

***Aerofoil Climafan  
Plate Mounted & Short Cased Axials  
50 Hz***



AIRTREND Limited  
Predstavništvo u Beogradu  
Kumanovska 14, 11000 Beograd  
Tel: 011/3836886, 3085740  
Faks: 011/3444113  
e-mail: gobrid@eunet.rs  
web: www.airtrend.rs

**FläktWoods**



## CONTENTS

---

	<b>Page:</b>
<b>Woods Worldwide</b>	<b>4-5</b>
<b>Quality Assurance</b>	<b>6</b>
<b>Specification</b>	<b>7</b>
<b>Test Methods</b>	<b>8</b>
<b>How To Specify</b>	<b>9</b>
<b>Guide To Fan Selection</b>	<b>10-11</b>
<b>Performance Data</b>	<b>12-53</b>
<b>Dimensions and Weights</b>	<b>54-55</b>
<b>Ancillaries</b>	<b>56</b>
<b>Useful Information</b>	<b>57-58</b>

# WOODS WORLDWIDE

Woods Air Movement are the acknowledged leaders in the specialised world of air movement technology. Over 90 year's experience in designing and manufacturing air moving equipment has kept Woods in the forefront of innovation, enabling the company to maintain their leadership in a sophisticated and competitive market. This experience enables Woods to engineer a product as right for the market as the AEROFOIL CLIMAFAN. A fan whose specification has been particularly defined by the needs of the Original Equipment Manufacturing Industry (OEM).

Designed after extensive market research to meet every requirement for volume air flow whilst being quiet, light, efficient and competitively priced.

By setting and achieving far-sighted objectives for the AEROFOIL CLIMAFAN, Woods of Colchester have produced a range of fans to satisfy the most exacting demands of OEM users world-wide. The AEROFOIL CLIMAFAN Series are supplied fully assembled, either plate mounted or short cased, and ready for installation in air movement applications.

AEROFOIL CLIMAFANS contain many features which ensure simple installation, optimum performance, maximum safety in operation and minimum maintenance.





- **Low installed noise levels**  
allows the customer to achieve stringent environmental noise requirements with their equipment.
- **Lightweight Construction and Low Levels of Vibration**  
the combination of state of the art manufacturing techniques and the use of modern materials results in a product which can be readily installed on lightweight heat transfer structures, statically balanced to minimise vibration levels.
- **A Unique Aerodynamic Blade Section**  
based on the latest aerospace technology, the impeller optimises the air performance that can be achieved from a non-ducted installation, and is designed specifically for the intended application.
- **High Efficiency Performance**  
the adjustable pitch angle impeller allows the optimum aerodynamic performance to be achieved for a given motor output, therefore minimising running costs.
- **500 to 1000 mm Size Range**  
Fans are available in sizes 500 mm to 1000 mm diameter and most are available for either single or three phase operation.
- **Flexibility of Design**  
The alternative mounting configurations allows the customer to match the product best suited to the individual application.
- **Product Reliability and Safety**  
All rotating aluminium components are inspected using our dedicated real time radiography suite to ensure acceptable quality of castings.

- **Reliability of Catalogue Performance**

The fans are tested to the latest British and International standards, the Aerofoil Climafan is catalogued showing a Type A, non-ducted performance to match the customers installed configuration.

- **All Fans Weatherproof IP55**

All fans are weatherproof IP55, and have integral overheat protection as standard on most single phase motors.

- **2 Year Guarantee**

Aerofoil Climafans are guaranteed for a period of 2 years, when installed in accordance with Woods operating and maintenance instructions.



## QUALITY SYSTEMS

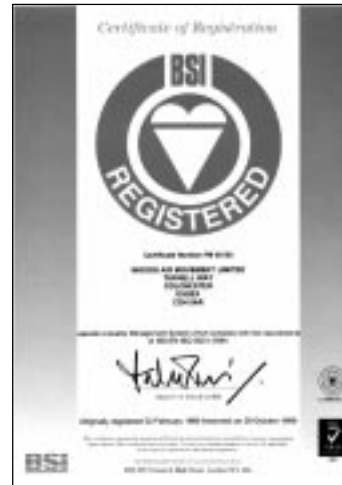
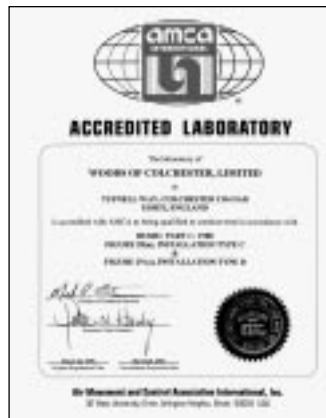

Woods Air Movement Limited certifies that the Aerofoil shown herein is licensed to bear the AMCA Seal. The ratings shown are based on tests and procedures performed in accordance with AMCA Publication 211 and comply with the requirements of the AMCA Certified Ratings Program.

### Quality Systems

Woods Air Movement Limited is committed to Quality Assurance. Registration to BS EN ISO 9001.94, means that Woods design is quality assured as well as the manufacture.

Our commitment to Quality Assurance doesn't stop with the hardware. The performance data comes from standard tests carried out in Woods own laboratory which is British Standard and AMCA accredited. Those fans which are AMCA licensed for aerodynamic performance are identified by the AMCA Seal on the appropriate characteristic curve(s).

A Aerofoil can be bought with the confidence as with all Woods products, that it will achieve the published performance data and match the assured quality. All the Woods JM Aerofoils are fitted with IP55 motors as standard, and come with a 2 year ex works warranty.



## SPECIFICATION

### Motors

Constructed from aluminium as standard with special "T" slot and pad mounted fixings.  
Suitable for horizontal through to vertical shaft operation.  
Supplied IP55, with removable drain plugs.  
Bearings lubricated with wide temperature range grease, relubricatable or sealed for life depending on size.  
Continuous operating range -40° C to +50° C, (for other operating temperatures please enquire).  
Insulation class F as standard.  
2 speed operation by Delta/Star ( $\Delta/\lambda$ ) reconnection available on most three phase motors.  
Integral pre-wired capacitor on most single phase fans.  
Ratings comply with BS5000 Part 99 and IEC 34-1.



### Electrical Supply

220-240 V 50 Hz single phase (1 $\phi$ )  
380-420 V 50 Hz three phase (3 $\phi$ )  
(60 Hz variants and other voltages are available on request)

Speed control can be provided by Woods of Colchester's range of electronic and auto-transformer type speed controllers. Speed control details are based on the adoption of the more usual and technically superior three-wire circuit.

The single phase controller rating may be less than the full load current, as only the "U" phase voltage is varied.

Many of the regulatable, three phase motors may be offered for 2 speed applications by Delta/Star ( $\Delta/\lambda$ ) reconnection. Each performance chart states the impeller Pitch Angle where approximately 80% of the full speed can be obtained by this method. Other Pitch Angles may offer other than 80% of full speed when the motor is reconnected in Star ( $\lambda$ ).

### Impellers

Aluminium hub and clamp-plate, with either three or six equally spaced, fully adjustable, moulded, black, ultra violet stabilised, glass coupled polypropylene aerofoil section blades.  
All rotating aluminium components are X-ray examined prior to machining to ensure quality.  
Balanced to BS6861 Part 1 1987 (ISO 1940-1986) Grade G6.3.  
Corrosion resistant and suitable for continuous outside use from -40°C to +50°C, (for other operating temperatures please enquire).



### Ancillaries

#### Plate Mounted

Motor and impeller side guards to comply with BS848 Pt 5, and draft ISO standard.  
Choice of auto-transformer or electronic speed controllers.  
2 speed switch for Delta/Star ( $\Delta/\lambda$ ) reconnection.

#### Short Cased Fans

Motor and Impeller side guards to comply with BS848 Pt 5., and draft ISO standard.  
Choice of auto-transformer or electronic speed controllers.  
2 speed switch for Delta/Star ( $\Delta/\lambda$ ) reconnection.  
Silencers.

### Finish

#### Plate Mounted

Mounting plates, mounting arms and guards are all hot dipped galvanised after manufacture, (in accordance with BS729:1971).  
Motors, aluminium alloy self finish.

#### Short Cased Fans

Fan casings, mounting arms, mounting feet and guards are all hot dipped galvanised after manufacture, (in accordance with BS729:1971).  
Motors, aluminium self finish.

## TEST METHODS

### Testing

The air and sound performance data has been measured by the latest version of British and International Standards:-

BS848 Pt 1 1980, (ISO CD5801) methods of testing air performance.

BS848 Pt 2 1985, method of noise testing.

It is essential, when comparing fan performances, that the same installation category and test standards are used at all times.



### Acoustic Data

The sound levels quoted are based on tests carried out under the Woods certified laboratory conditions. Using the spectrum corrections stated on each performance chart, an unweighted or "A" weighted sound power spectrum can be obtained for both the inlet and outlet side of the fan.



*Anechoic Test Suite at the Colchester site.*

*Flow Rate Testing.*

### Speed Regulatable Versions

If a speed regulatable version is required, (or Delta/Star ( $\Delta/\lambda$ ) reconnect on 3 phase versions) the duty volume flow required should be multiplied by 1.05 prior to fan selection being made.

### Motor Ratings

The motor ratings, starting, full load currents and speeds refer to the maximum output of the motor. When the impeller does not require the full output, the power and current will be less than the maximum quoted.



*Computer-automated fan test room.*

### Air Performance

The catalogue performances for plate mounted fans are certified in accordance with the BSI C.A.M.E scheme, type A installation ( Non-ducted).

## HOW TO SPECIFY

### Specifying The Fan

Having chosen the fan most suitable for your individual application.

Please specify as follows:-

1. The fan shall be manufactured by Woods of Colchester model type Aerofoil Climafan, plate mounted or short cased (S-type).
2. Motors, squirrel cage type, insulated to class F, bearings lubricated with high temperature grease, keyed shaft. To comply with BS5000 Pt 99 and IEC 34-1. Weatherproof to IP55. (Overheat protection provided on most single phase motors).
3. Impellers, aluminium hub and clamp-plate, with either three or six equally spaced, fully adjustable moulded, black, ultra violet stabilised, glasscoupled polypropylene aerofoil section blades. All rotating aluminium components to be X-ray examined prior to machining to ensure quality.
4. Mounting plates, manufactured from mild steel with hot dipped galvanised finish.
5. Mounting Arms, manufactured from mild steel with hot dipped galvanised finish.
6. Guards, manufactured to BS848 Pt 5 1986 from mild steel, with hot dipped galvanised finish
7. Performance shall be established in accordance with BS848 Pt 1 1980, type A, method of testing air performance (equivalent to ISO DP5801 Pt 1), and BS848 Pt 2 1985 method of noise testing. All plate mounted air performance figures shall have been independently verified in accordance with the BSI C.A.M.E. Scheme.

### Ordering The Fan

After identifying the best fan for your application please order as follows:-

1. Fan type: Plate mounted (above or below plate), or Short Cased (S-type) Form A or Form B. (See pages 54 and 55).
2. Fan Code:  
eg: 63AC /8 /6 /24  
where: 63 denotes the Fan impeller diameter in centimetres.  
AC denotes "AEROFOIL CLIMAFAN"  
/8 denotes a nominal 8 pole speed.  
/6 denotes the number of blades.  
/20 denotes the Pitch Angle for the required duty.
3. Quantity required.
4. Duty required at standard air and temperature e.g. 1.4 m<sup>3</sup>/s @ 60 Pa.
5. Motor. eg: CT9
6. Electrical Supply:  
220-240 V / 50 Hz / 1 $\phi$   
380-420 V / 50 Hz / 3 $\phi$
7. Ancillary items required.  
  
Plate Mounted:  
Impeller and Motor Side Guards, Speed Controller (electronic or auto-transformer) or 2 speed switch type MDS3.10.  
  
Short Cased (S-type):  
Impeller and Motor Side Guards, Silencers with or without pod, Speed Controller (electronic or auto-transformer) or 2 speed switch type MDS3.10.



## GUIDE TO FAN SELECTION

### Procedure

#### 1. Guide to Chart Numbers of Possible Selections

The charts are arranged in order of fan diameter, starting at 500 mm, up to 1000 mm diameter, and in order of fan speed for each diameter, 6 and 3 bladed fan impeller.

**NOTE:** The chart numbers lead to a variety of fan sizes, impeller configurations and speeds. The fan selected from the alternatives available will depend on the most critical factor for the particular application - Volume Flow and Pressure required, Size, Power Consumption, Sound Level or First Cost.

#### 2. Required Duty

Establish the volume flow and static pressure required of an individual fan at Standard Air (1.2 kg/m<sup>3</sup>).

#### 3. Selection on Individual Fan Charts

The data provided on each performance chart is specifically for non-ducted - Type A (non-ducted) installations for both plate mounted or short cased (S-type) fans. Providing reasonable Type A conditions are maintained in installation of the fans, no additional factors to volume flow or pressure need be incorporated for a suitable selection to be made.

Plot the duty on the selected fan charts to establish blade angle, sound level, absorbed power, motor size and rating, for the particular arrangement on the application.

### Selection Example

**D.** Duty Point Required - @ Standard Air (1.2 kg/m<sup>3</sup>).

1.4 m<sup>3</sup>/s @ 60 Pa static pressure.

**1.**

Volume Flow = 1.4 m<sup>3</sup>/s

**2.**

Fan Static Pressure = 60 Pa

**3.**

Overall inlet Sound Power Level = 63 L<sub>WA</sub>

**4.**

Pitch Angle required to achieve Duty Point = 24°

**5.**

Corrections to overall Sound Power level for 24° Pitch Angle.

Sound Power Level (Un-weighted)	Frequency Hz								
	63	125	250	500	1K	2K	4K	8K	
Inlet	64	64	63	61	58	53	49	47	Lw
Outlet	71	70	67	64	60	55	51	51	Lw

**6.**

Absorbed Power @ Duty Point @ 24° Pitch Angle = 0.153 kW.

**7.**

Suitable Motor for fixed speed application, 3 phase supply = CT9

Motor Data:

Motor Rating (kW) = 0.3  
 Full Load (A) = 1.4  
 Starting Current (A) = 2.6

# AEROFOIL CLIMAFAN



BS 5750 Pt 1  
EN 29001  
ISO 9001

## Fan Code: 63AC/8/6/...

## 630 mm 680 rev/min 6 Blades 50 Hz

### Performance Data

#### BS 848 Pt 1 1980

Performance shown is specifically for non-ducted installations.

### Sound Data

#### BS 848 Pt 2 1985

Single figures on performance curves are overall inlet sound power levels, "A" weighted ( $L_{WA}$  re: 1 pW), derived from measurements taken in Woods laboratory specifically under non-ducted free field conditions. For sound power levels in eight octave bands, apply the following corrections to the overall level:

#### Inlet Levels

	Pitch Angle	Frequency Hz							
		63	125	250	500	1K	2K	4K	8K
$L_{WA}$	8 - 18	-29	-17	-8	-4	-6	-9	-17	-23
$L_W$	8 - 18	-3	-1	+1	-1	-6	-10	-18	-22
$L_{WA}$	20 - 36	-25	-15	-9	-5	-5	-9	-13	-17
$L_W$	20 - 36	+1	+1	0	-2	-5	-10	-14	-16

#### Outlet Levels

	Pitch Angle	Frequency Hz							
		63	125	250	500	1K	2K	4K	8K
$L_{WA}$	8 - 18	-21	-10	-4	-2	-4	-7	-14	-20
$L_W$	8 - 18	+5	+6	+5	+1	-4	-8	-15	-19
$L_{WA}$	20 - 36	-18	-9	-5	-2	-3	-7	-11	-13
$L_W$	20 - 36	+8	+7	+4	+1	-3	-8	-12	-12

  Extra performance only from plate mounted fans.

  Three blade performance available. See chart number (Sample -1).

### Electrical Data

220-240 V / 50 Hz / 1  $\phi$

Motor	Fixed Speed				Speed Controllable					
	Pitch Angle (°)	Motor Rating (kW)	Full Load (A)	Starting Current (A)	Pitch Angle (°)	Motor Rating (kW)	Full Load (A)	Starting Current (A)	Speed Controller	
									Electronic	Auto-Transformer
BT9	10 - 16	0.11	1.1	1.9	10 - 12	0.09	1	1.7	ME1.3	MT1.5
CT5	18 - 22	0.16	1.5	2.5	16 - 18	0.13	1.3	2.1	ME1.3	MT1.5
CT9	28 - 36	0.3	2.7	3.5	28 - 32	0.25	2.3	3.4	ME1.6	MT1.5

380-420 V / 50 Hz / 3  $\phi$

Motor	Fixed Speed				Speed Controllable					
	Pitch Angle (°)	Motor Rating (kW)	Full Load (A)	Starting Current (A)	Pitch Angle (°)	Motor Rating (kW)	Full Load (A)	Starting Current (A)	Speed Control	
									Electronic	$\Delta/\Lambda$ * Pitch Angle
BT9	8 - 16	0.11	0.6	1.1	10 - 12	0.09	0.5	0.9	ME3.2D	12
CT5	18 - 22	0.16	0.8	1.5	14 - 18	0.13	0.7	1.5	ME3.2D	18
CT9	24 - 36	0.3	1.4	2.6	26 - 32	0.25	1.2	2.6	ME3.2D	32

\* By connecting these 3 phase motors in star ( $\Lambda$ ), a second speed will be obtained approximately 80% of the full speed at the angle shown. (A Woods two speed switch type MDS3.10 is available). For dimensions and weights of this fan please refer to pages 54 and 55

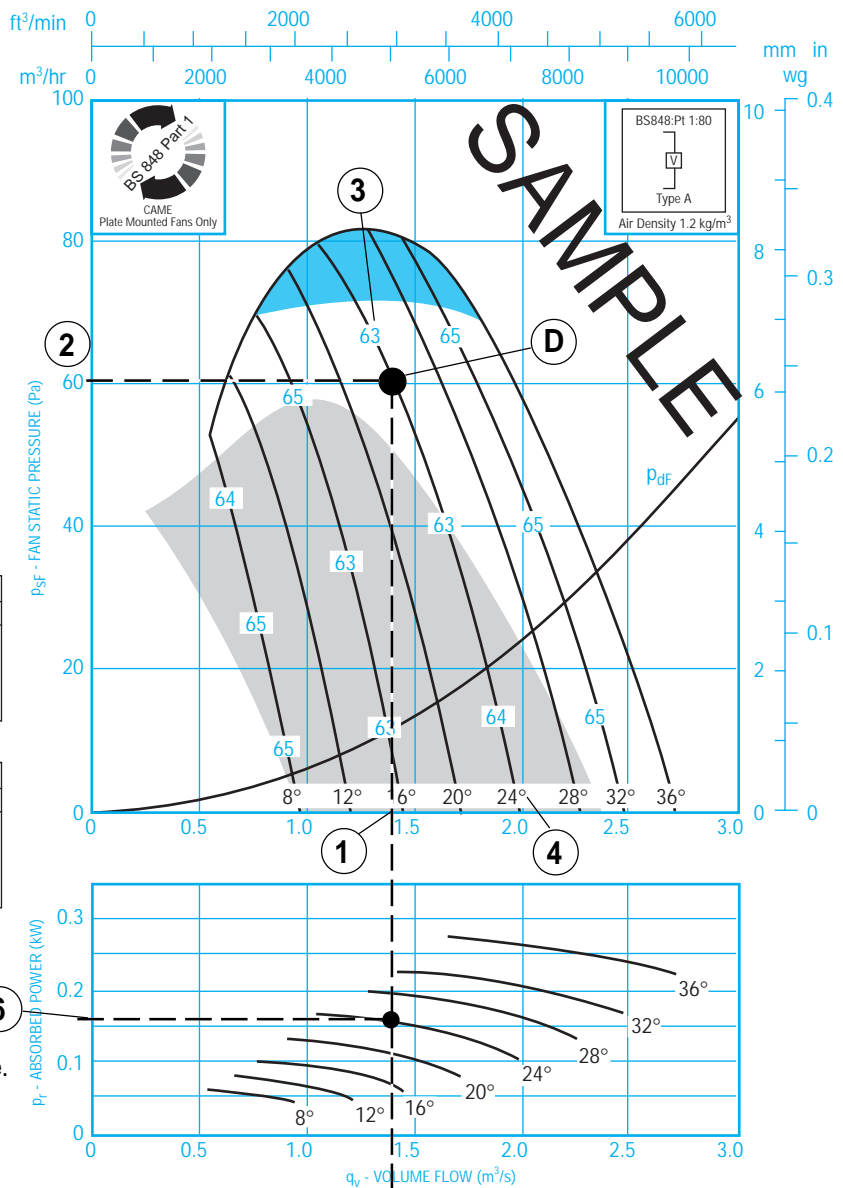

Chart No. SAMPLE

# AEROFOIL CLIMAFAN



## Fan Code: 50AC/6/3/...

## 500 mm 915 rev/min 3 Blades 50 Hz



### Performance Data

#### BS 848 Pt 1 1980

Performance shown is specifically for non-ducted installations.

### Sound Data

#### BS 848 Pt 2 1985

Single figures on performance curves are overall inlet sound power levels, "A" weighted ( $L_{WA}$  re: 1 pW), derived from measurements taken in Woods laboratory specifically under non-ducted free field conditions. For sound power levels in eight octave bands, apply the following corrections to the overall level:

#### Inlet Levels

	Pitch Angle	Frequency Hz							
		63	125	250	500	1K	2K	4K	8K
$L_{WA}$	8 - 18	-28	-15	-8	-6	-6	-8	-13	-23
$L_W$	8 - 18	-2	+1	-3	-6	-9	-14	-22	
$L_{WA}$	20 - 36	-25	-15	-9	-7	-6	-6	-9	-18
$L_W$	20 - 36	+1	+1	0	-4	-6	-7	-10	-17

#### Outlet Levels

	Pitch Angle	Frequency Hz							
		63	125	250	500	1K	2K	4K	8K
$L_{WA}$	8 - 18	-25	-13	-7	-5	-4	-6	-11	-20
$L_W$	8 - 18	+1	+3	+2	-2	-4	-7	-12	-19
$L_{WA}$	20 - 36	-22	-13	-8	-6	-4	-3	-6	-15
$L_W$	20 - 36	+4	+3	+1	-3	-4	-4	-7	-14

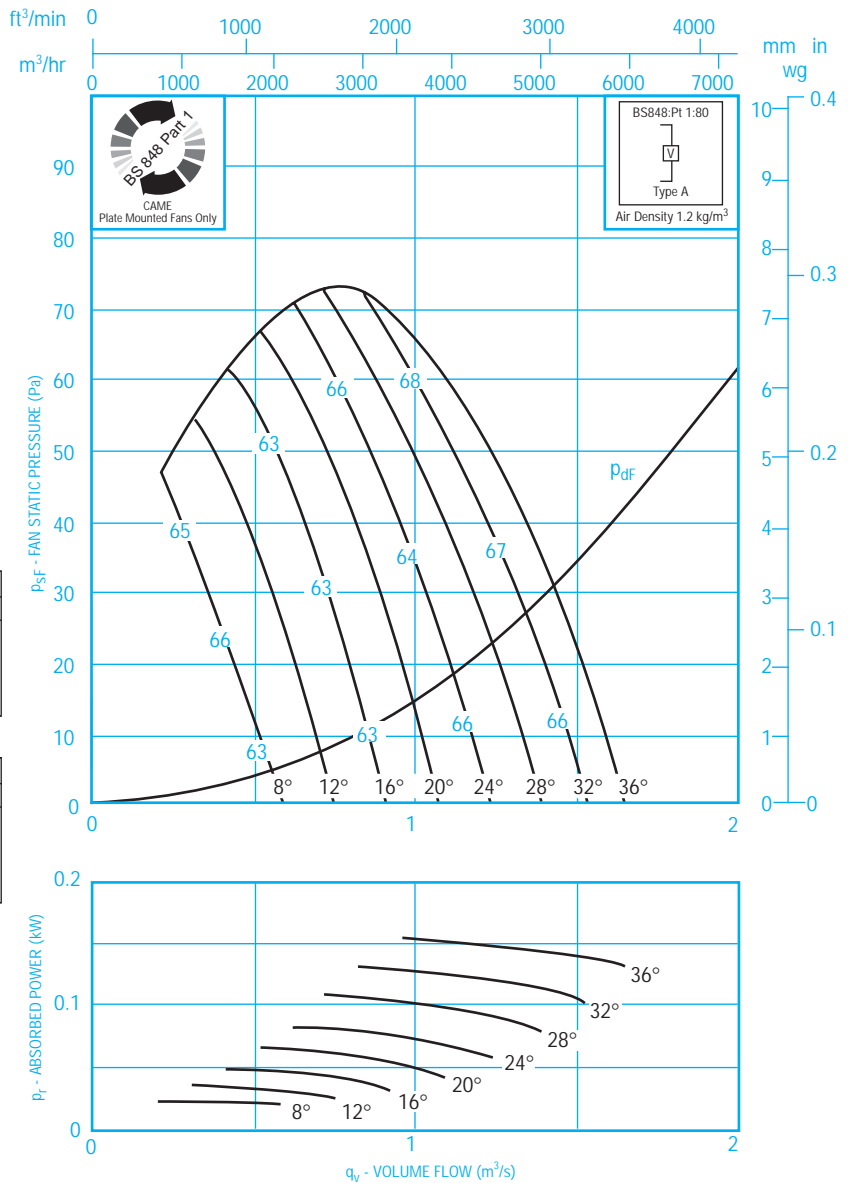

### Electrical Data

220-240 V / 50 Hz / 1  $\phi$

Chart No. 1

Motor	Fixed Speed				Speed Controllable					
	Pitch Angle (°)	Motor Rating (kW)	Full Load (A)	Starting Current (A)	Pitch Angle (°)	Motor Rating (kW)	Full Load (A)	Starting Current (A)	Speed Controller	
									Electronic	Auto-Transformer
BT5	14 - 30	0.12	1	1.6	18 - 24	0.09	0.8	1.6	ME1.1	MT1.1
BT9	32 - 36	0.19	1.5	2.8	32 - 34	0.14	1.2	2.8	ME1.3	MT1.5
CT5	-	-	-	-	36	0.19	1.8	3	ME1.3	MT1.5

380-420 V / 50 Hz / 3  $\phi$

Motor	Fixed Speed				Speed Controllable					
	Pitch Angle (°)	Motor Rating (kW)	Full Load (A)	Starting Current (A)	Pitch Angle (°)	Motor Rating (kW)	Full Load (A)	Starting Current (A)	Speed Control	
									Electronic	$\Delta/\Lambda$ * Pitch Angle
BT5	8 - 30	0.12	0.5	1.2	20 - 24	0.09	0.4	1.2	ME3.2D	24
BT9	32 - 36	0.19	0.7	1.8	26 - 34	0.14	0.6	1.8	ME3.2D	34
-	-	-	-	-	-	-	-	-	-	-

\* By connecting these 3 phase motors in star ( $\Lambda$ ), a second speed will be obtained approximately 80% of the full speed at the angle shown. (A Woods two speed switch type MDS3.10 is available). For dimensions and weights of this fan please refer to pages 54 and 55.

# AEROFOIL CLIMAFAN



## Fan Code: 50AC/6/6/...

## 500 mm 915 rev/min 6 Blades 50 Hz

### Performance Data

#### BS 848 Pt 1 1980

Performance shown is specifically for non-ducted installations.

### Sound Data

#### BS 848 Pt 2 1985

Single figures on performance curves are overall inlet sound power levels, "A" weighted ( $L_{WA}$  re: 1 pW), derived from measurements taken in Woods laboratory specifically under non-ducted free field conditions. For sound power levels in eight octave bands, apply the following corrections to the overall level:

#### Inlet Levels

	Pitch Angle	Frequency Hz							
		63	125	250	500	1K	2K	4K	8K
$L_{WA}$	8 - 18	-29	-16	-6	-5	-6	-9	-16	-25
$L_W$	8 - 18	-3	0	+3	-2	-6	-10	-17	-24
$L_{WA}$	20 - 36	-28	-17	-7	-6	-6	-7	-12	-21
$L_W$	20 - 36	-2	-1	+2	-3	-6	-8	-13	-20

#### Outlet Levels

	Pitch Angle	Frequency Hz							
		63	125	250	500	1K	2K	4K	8K
$L_{WA}$	8 - 18	-27	-13	-5	-4	-4	-6	-13	-21
$L_W$	8 - 18	-1	+3	+4	-1	-4	-7	-14	-20
$L_{WA}$	20 - 36	-26	-13	-6	-5	-4	-4	-9	-18
$L_W$	20 - 36	0	+3	+3	-2	-4	-5	-10	-17

Three blade performance available. See chart number 1.

### Electrical Data

220-240 V / 50 Hz / 1  $\phi$

Motor	Fixed Speed				Speed Controllable					
	Pitch Angle (°)	Motor Rating (kW)	Full Load (A)	Starting Current (A)	Pitch Angle (°)	Motor Rating (kW)	Full Load (A)	Starting Current (A)	Speed Controller	
									Electronic	Auto-Transformer
BT5	10 - 22	0.12	1	1.6	12 - 18	0.09	0.8	1.6	ME1.1	MT1.1
BT9	24 - 32	0.19	1.5	2.8	24 - 26	0.14	1.2	2.8	ME1.3	MT1.5
CT5	36	0.37	2.9	4	28 - 32	0.19	1.8	3	ME1.3	MT1.5

380-420 V / 50 Hz / 3  $\phi$

Motor	Fixed Speed				Speed Controllable					
	Pitch Angle (°)	Motor Rating (kW)	Full Load (A)	Starting Current (A)	Pitch Angle (°)	Motor Rating (kW)	Full Load (A)	Starting Current (A)	Speed Control	
									Electronic	$\Delta/\Lambda$ * Pitch Angle
BT5	8 - 22	0.12	0.5	1.2	14 - 18	0.09	0.4	1.2	ME3.2D	18
BT9	24 - 32	0.19	0.7	1.8	20 - 26	0.14	0.6	1.8	ME3.2D	26
CT5	34 - 36	0.37	1.3	3.3	36	0.3	1.1	3.3	ME3.2D	-

\* By connecting these 3 phase motors in star ( $\Lambda$ ), a second speed will be obtained approximately 80% of the full speed at the angle shown. (A Woods two speed switch type MDS3.10 is available). For dimensions and weights of this fan please refer to pages 54 and 55.

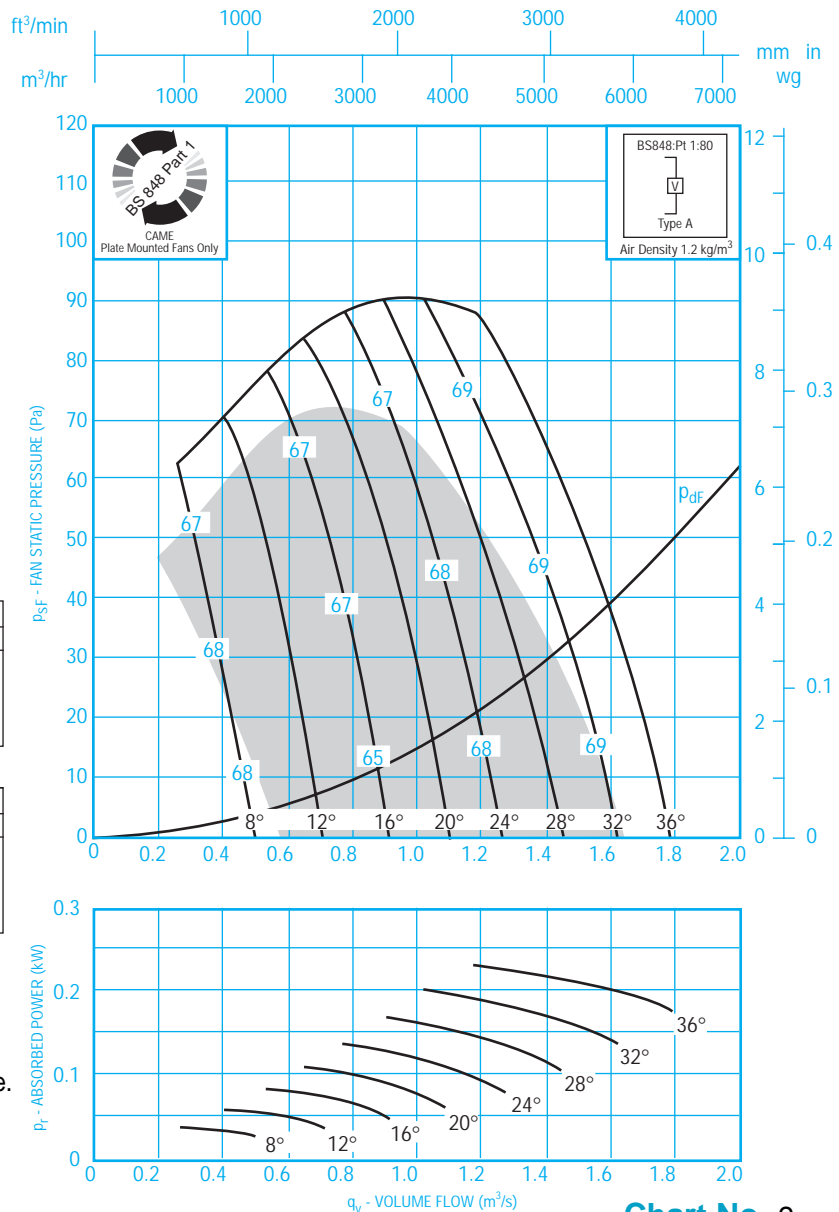

Chart No. 2

# AEROFOIL CLIMAFAN



## Fan Code: 50AC/4/3/...

## 500 mm 1420 rev/min 3 Blades 50 Hz



### Performance Data

#### BS 848 Pt 1 1980

Performance shown is specifically for non-ducted installations.

### Sound Data

#### BS 848 Pt 2 1985

Single figures on performance curves are overall inlet sound power levels, "A" weighted ( $L_{WA}$  re: 1 pW), derived from measurements taken in Woods laboratory specifically under non-ducted free field conditions. For sound power levels in eight octave bands, apply the following corrections to the overall level:

#### Inlet Levels

	Pitch Angle	Frequency Hz							
		63	125	250	500	1K	2K	4K	8K
$L_{WA}$	8 - 18	-31	-20	-10	-5	-7	-8	-11	-20
$L_W$	8 - 18	-5	-4	-1	-2	-7	-9	-12	-19
$L_{WA}$	20 - 36	-26	-17	-10	-7	-7	-7	-8	-15
$L_W$	20 - 36	0	-1	-1	-4	-7	-8	-9	-14

#### Outlet Levels

	Pitch Angle	Frequency Hz							
		63	125	250	500	1K	2K	4K	8K
$L_{WA}$	8 - 18	-28	-18	-9	-4	-5	-6	-9	-17
$L_W$	8 - 18	-2	-2	0	-1	-5	-7	-10	-16
$L_{WA}$	20 - 36	-24	-16	-9	-6	-5	-5	-5	-12
$L_W$	20 - 36	+2	0	0	-3	-5	-6	-6	-11

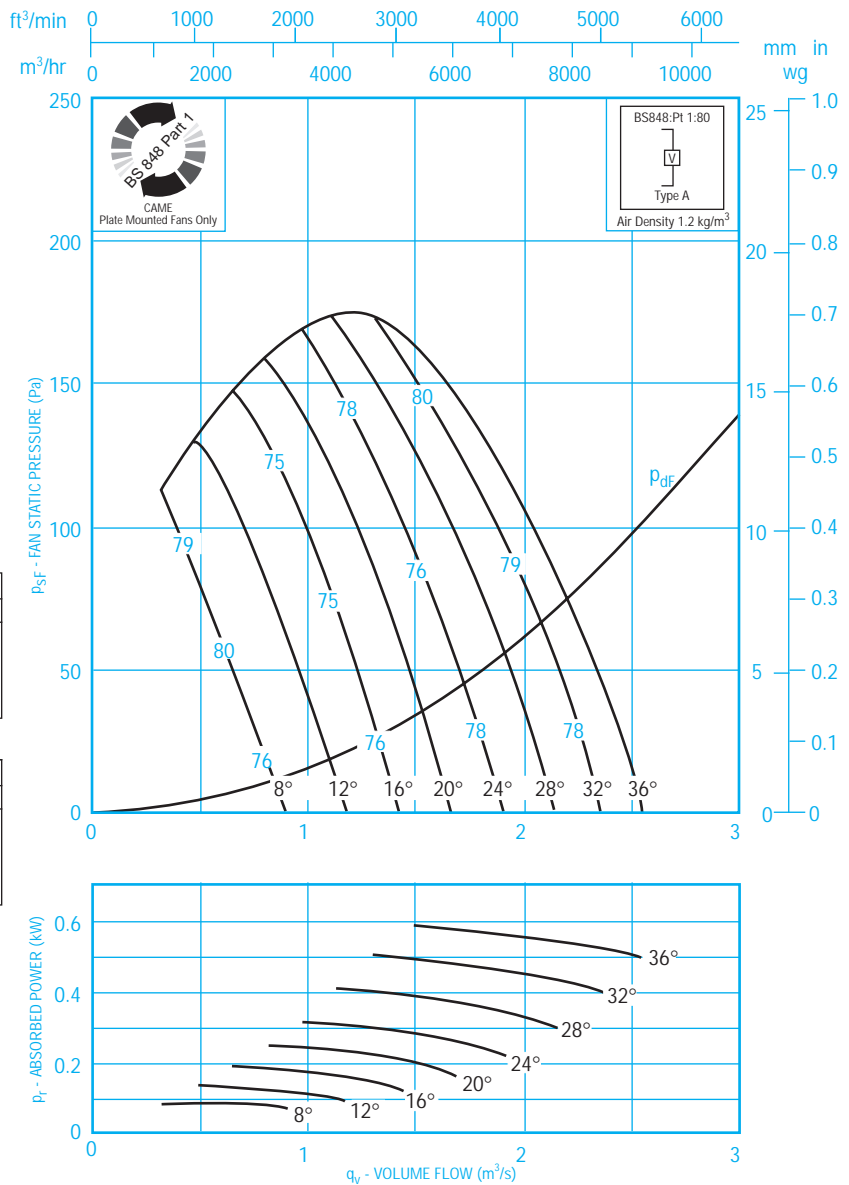

### Electrical Data

220-240 V / 50 Hz / 1  $\phi$

Chart No. 3

Motor	Fixed Speed				Speed Controllable					
	Pitch Angle (°)	Motor Rating (kW)	Full Load (A)	Starting Current (A)	Pitch Angle (°)	Motor Rating (kW)	Full Load (A)	Starting Current (A)	Speed Controller	
									Electronic	Auto-Transformer
BT5	16 - 20	0.23	1.6	2.7	16 - 18	0.2	1.5	2.7	ME1.3	MT1.5
BT9	22 - 38	0.39	2.7	5.3	20 - 22	0.3	2.1	5.3	ME1.3	MT1.5
CT5	30 - 36	0.7	4.4	9.5	32 - 34	0.55	3.7	9.5	ME1.6	MT1.5

380-420 V / 50 Hz / 3  $\phi$

Motor	Fixed Speed				Speed Controllable					
	Pitch Angle (°)	Motor Rating (kW)	Full Load (A)	Starting Current (A)	Pitch Angle (°)	Motor Rating (kW)	Full Load (A)	Starting Current (A)	Speed Control	
									Electronic	$\Delta/\Lambda$ * Pitch Angle
BT5	8 - 18	0.23	0.7	2.4	12 - 16	0.2	0.7	2.4	ME3.2D	16
BT9	20 - 28	0.39	1.1	4.6	18 - 24	0.3	0.9	4.6	ME3.2D	24
CT5	30 - 36	0.71	1.9	6.5	30 - 36	0.58	1.7	6.5	ME3.2D	36

\* By connecting these 3 phase motors in star ( $\Lambda$ ), a second speed will be obtained approximately 80% of the full speed at the angle shown. (A Woods two speed switch type MDS3.10 is available). For dimensions and weights of this fan please refer to pages 54 and 55.



# AEROFOIL CLIMAFAN



## Fan Code: 50AC/4/6/...

## 500 mm 1420 rev/min 6 Blades 50 Hz

### Performance Data

#### BS 848 Pt 1 1980

Performance shown is specifically for non-ducted installations.

### Sound Data

#### BS 848 Pt 2 1985

Single figures on performance curves are overall inlet sound power levels, "A" weighted ( $L_{WA}$  re: 1 pW), derived from measurements taken in Woods laboratory specifically under non-ducted free field conditions. For sound power levels in eight octave bands, apply the following corrections to the overall level:

#### Inlet Levels

	Pitch Angle	Frequency Hz							
		63	125	250	500	1K	2K	4K	8K
$L_{WA}$	8 - 18	-34	-20	-11	-4	-6	-8	-12	-23
$L_W$	8 - 18	-8	-4	-2	-1	-6	-9	-13	-22
$L_{WA}$	20 - 36	-32	-18	-11	-5	-6	-7	-9	-18
$L_W$	20 - 36	-6	-2	-2	-2	-6	-8	-10	-17

#### Outlet Levels

	Pitch Angle	Frequency Hz							
		63	125	250	500	1K	2K	4K	8K
$L_{WA}$	8 - 18	-32	-16	-9	-3	-5	-6	-10	-20
$L_W$	8 - 18	-6	0	0	0	-5	-7	-11	-19
$L_{WA}$	20 - 36	-30	-14	-8	-5	-5	-5	-7	-15
$L_W$	20 - 36	-4	+2	+1	-2	-5	-6	-8	-14

Three blade performance available. See chart number 3

### Electrical Data

220-240 V / 50 Hz / 1  $\phi$

Chart No. 4

Motor	Fixed Speed				Speed Controllable					
	Pitch Angle (°)	Motor Rating (kW)	Full Load (A)	Starting Current (A)	Pitch Angle (°)	Motor Rating (kW)	Full Load (A)	Starting Current (A)	Speed Controller	
									Electronic	Auto-Transformer
BT9	16 - 20	0.39	2.7	5.3	12 - 16	0.3	2.1	5.3	ME1.3	MT1.5
CT5	22 - 30	0.7	4.4	9.5	24 - 26	0.55	3.7	9.5	ME1.6	MT1.5
CT9	36	1.3	8.2	23	32 - 36	0.9	5.8	19	ME1.6	MT1.8

380-420 V / 50 Hz / 3  $\phi$

Motor	Fixed Speed				Speed Controllable					
	Pitch Angle (°)	Motor Rating (kW)	Full Load (A)	Starting Current (A)	Pitch Angle (°)	Motor Rating (kW)	Full Load (A)	Starting Current (A)	Speed Control	
									Electronic	$\Delta/\lambda$ * Pitch Angle
BT9	14 - 18	0.39	1.1	4.6	12 - 16	0.3	0.9	4.6	ME3.2D	16
CT5	20 - 32	0.71	1.9	6.2	22 - 26	0.58	1.7	6.5	ME3.2D	26
CT9	34 - 36	1.4	3.5	14	28 - 36	0.9	2.3	9	ME3.2D	36

\* By connecting these 3 phase motors in star ( $\lambda$ ), a second speed will be obtained approximately 80% of the full speed at the angle shown. (A Woods two speed switch type MDS3.10 is available). For dimensions and weights of this fan please refer to pages 54 and 55.

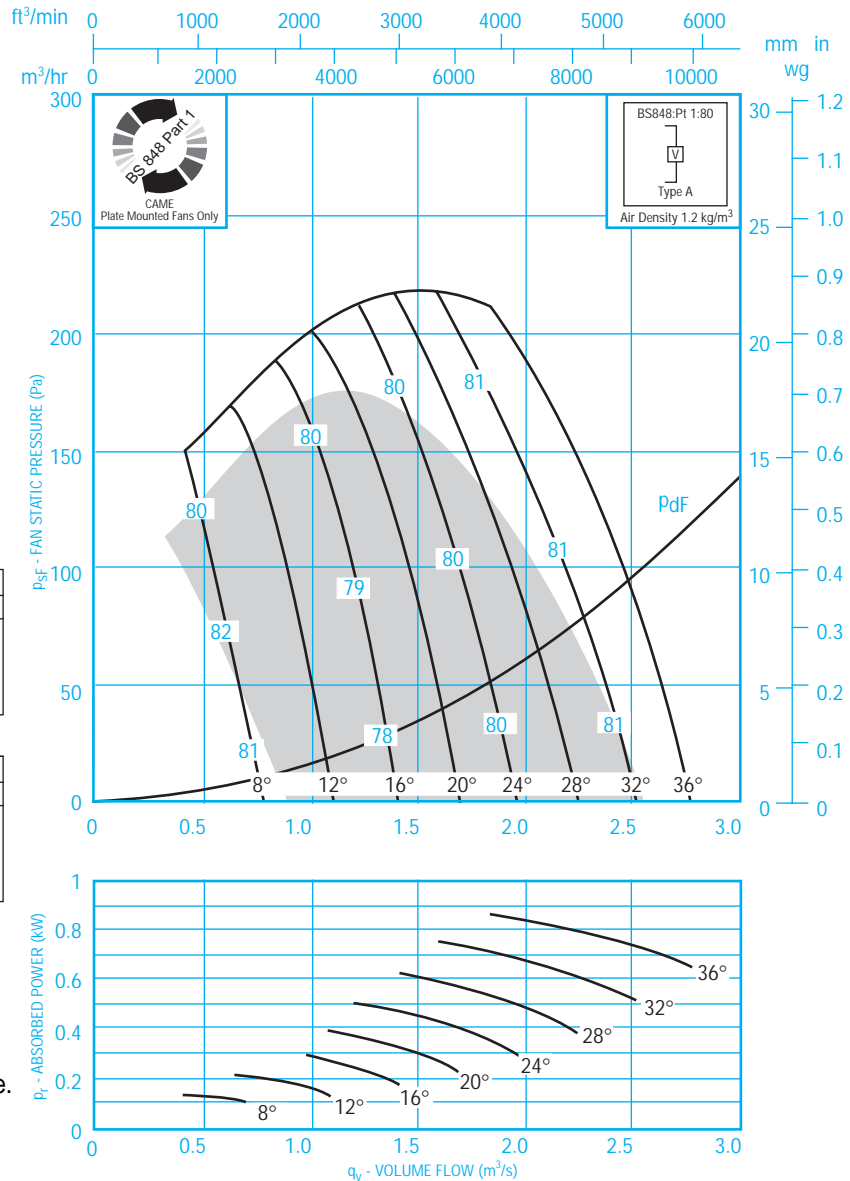

# AEROFOIL CLIMAFAN



## Fan Code: 50AC/2/3/...

## 500 mm 2910 rev/min 3 Blades 50 Hz



### Performance Data

#### BS 848 Pt 1 1980

Performance shown is specifically for non-ducted installations.

### Sound Data

#### BS 848 Pt 2 1985

Single figures on performance curves are overall inlet sound power levels, "A" weighted ( $L_{WA}$  re: 1 pW), derived from measurements taken in Woods laboratory specifically under non-ducted free field conditions. For sound power levels in eight octave bands, apply the following corrections to the overall level:

#### Inlet Levels

	Pitch Angle	Frequency Hz							
		63	125	250	500	1K	2K	4K	8K
$L_{WA}$	8 - 18	-41	-24	-16	-6	-4	-7	-13	-19
$L_W$	8 - 18	-15	-8	-7	-3	-4	-8	-14	-18
$L_{WA}$	20 - 36	-39	-19	-12	-5	-5	-7	-11	-14
$L_W$	20 - 36	-13	-3	-3	-2	-5	-8	-12	-13

#### Outlet Levels

	Pitch Angle	Frequency Hz							
		63	125	250	500	1K	2K	4K	8K
$L_{WA}$	8 - 18	-39	-19	-14	-4	-1	-5	-10	-15
$L_W$	8 - 18	-13	-3	-5	-1	-1	-6	-11	-14
$L_{WA}$	20 - 36	-37	-14	-10	-3	-3	-5	-9	-10
$L_W$	20 - 36	-11	+2	-1	0	-3	-6	-10	-9

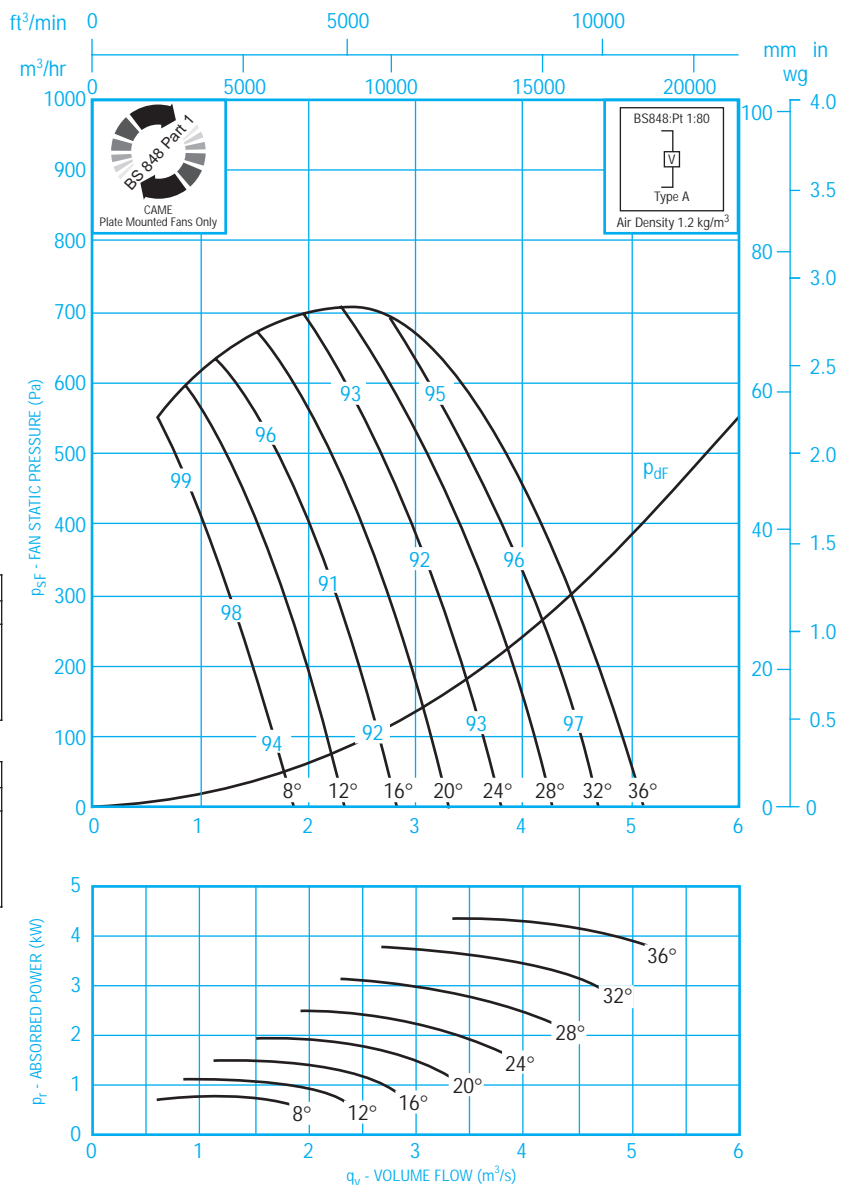

### Electrical Data

220-240 V / 50 Hz / 1  $\phi$

Chart No. 5

Motor	Fixed Speed				Speed Controllable					
	Pitch Angle (°)	Motor Rating (kW)	Full Load (A)	Starting Current (A)	Pitch Angle (°)	Motor Rating (kW)	Full Load (A)	Starting Current (A)	Speed Controller	
									Electronic	Auto-Transformer
CT9	12 - 14	1.4	8.3	27	-	-	-	-	-	-
F2225	18 - 24	2.7	14	50	-	-	-	-	-	-
F2229	26 - 34	4	21	85	-	-	-	-	-	-

380-420 V / 50 Hz / 3  $\phi$

Motor	Fixed Speed				Speed Controllable					
	Pitch Angle (°)	Motor Rating (kW)	Full Load (A)	Starting Current (A)	Pitch Angle (°)	Motor Rating (kW)	Full Load (A)	Starting Current (A)	Speed Control	
									Electronic	$\Delta/\Lambda$ * Pitch Angle
CT9	10 - 16	1.7	3.5	20	-	-	-	-	-	-
F2225	18 - 32	3.8	7.1	44	-	-	-	-	-	-
F2229	34 - 36	6.2	11	90	-	-	-	-	-	-

\* By connecting these 3 phase motors in star ( $\Lambda$ ), a second speed will be obtained approximately 80% of the full speed at the angle shown. (A Woods two speed switch type MDS3.10 is available). For dimensions and weights of this fan please refer to pages 54 and 55.

# AEROFOIL CLIMAFAN



## Fan Code: 50AC/2/6/...

## 500 mm 2910 rev/min 6 Blades 50 Hz

### Performance Data

#### BS 848 Pt 1 1980

Performance shown is specifically for non-ducted installations.

### Sound Data

#### BS 848 Pt 2 1985

Single figures on performance curves are overall inlet sound power levels, "A" weighted ( $L_{WA}$  re: 1 pW), derived from measurements taken in Woods laboratory specifically under non-ducted free field conditions. For sound power levels in eight octave bands, apply the following corrections to the overall level:

#### Inlet Levels

	Pitch Angle	Frequency Hz							
		63	125	250	500	1K	2K	4K	8K
$L_{WA}$	8 - 18	-45	-29	-17	-9	-3	-6	-11	-17
$L_W$	8 - 18	-19	-13	-8	-6	-3	-7	-12	-16
$L_{WA}$	20 - 36	-37	-28	-11	-8	-4	-6	-11	-16
$L_W$	20 - 36	-11	-12	-2	-5	-4	-7	-12	-15

#### Outlet Levels

	Pitch Angle	Frequency Hz							
		63	125	250	500	1K	2K	4K	8K
$L_{WA}$	8 - 18	-41	-29	-12	-6	-1	-4	-8	-14
$L_W$	8 - 18	-15	-13	-3	-3	-1	-5	-9	-13
$L_{WA}$	20 - 36	-32	-28	-6	-5	-2	-4	-8	-12
$L_W$	20 - 36	-6	-12	+3	-2	-2	-5	-9	-11

Three blade performance available. See chart number 5.

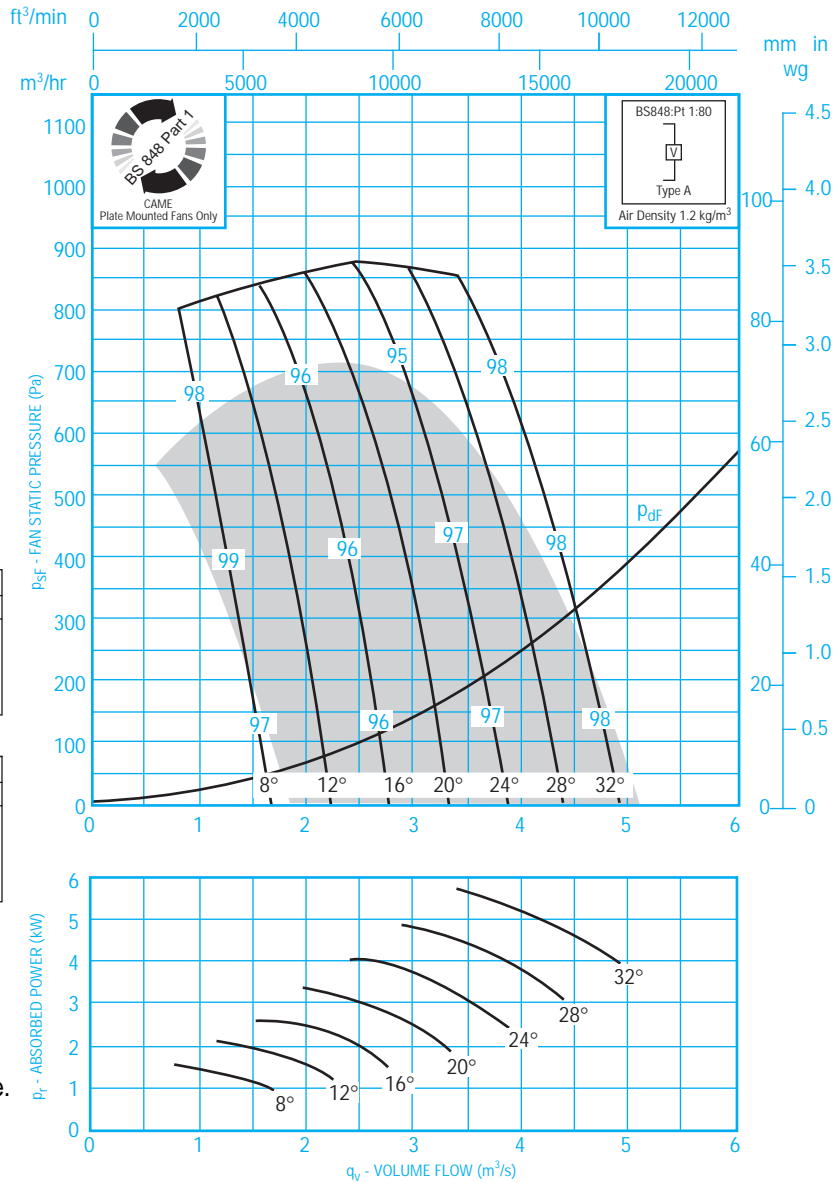

### Electrical Data

220-240 V / 50 Hz / 1  $\phi$

Chart No. 6

Motor	Fixed Speed				Speed Controllable					
	Pitch Angle (°)	Motor Rating (kW)	Full Load (A)	Starting Current (A)	Pitch Angle (°)	Motor Rating (kW)	Full Load (A)	Starting Current (A)	Speed Controller	
									Electronic	Auto-Transformer
F2225	12 - 16	2.7	14	50	-	-	-	-	-	-
F2229	18 - 24	4	21	85	-	-	-	-	-	-
-	-	-	-	-	-	-	-	-	-	-

380-420 V / 50 Hz / 3  $\phi$

Motor	Fixed Speed				Speed Controllable						
	Pitch Angle (°)	Motor Rating (kW)	Full Load (A)	Starting Current (A)	Pitch Angle (°)	Motor Rating (kW)	Full Load (A)	Starting Current (A)	Speed Control		
									Electronic	$\Delta/\Delta$ * Pitch Angle	
CT9	8	1.7	3.5	20	-	-	-	-	-	-	
F2225	10 - 22	3.8	7.1	44	-	-	-	-	-	-	
F2229	24 - 34	6.2	11	90	-	-	-	-	-	-	

\* By connecting these 3 phase motors in star ( $\Delta$ ), a second speed will be obtained approximately 80% of the full speed at the angle shown. (A Woods two speed switch type MDS3.10 is available). For dimensions and weights of this fan please refer to pages 54 and 55.

# AEROFOIL CLIMAFAN



## Fan Code: 56AC/8/3/...

## 560 mm 670 rev/min 3 Blades 50 Hz



### Performance Data

#### BS 848 Pt 1 1980

Performance shown is specifically for non-ducted installations.

### Sound Data

#### BS 848 Pt 2 1985

Single figures on performance curves are overall inlet sound power levels, "A" weighted ( $L_{WA}$  re: 1 pW), derived from measurements taken in Woods laboratory specifically under non-ducted free field conditions. For sound power levels in eight octave bands, apply the following corrections to the overall level:

#### Inlet Levels

	Pitch Angle	Frequency Hz							
		63	125	250	500	1K	2K	4K	8K
$L_{WA}$	8 - 18	-27	-15	-7	-5	-6	-9	-14	-22
$L_W$	8 - 18	-1	+1	+2	-2	-6	-10	-15	-21
$L_{WA}$	20 - 36	-24	-15	-9	-6	-6	-7	-11	-18
$L_W$	20 - 36	+2	+1	0	-3	-6	-8	-12	-17

#### Outlet Levels

	Pitch Angle	Frequency Hz							
		63	125	250	500	1K	2K	4K	8K
$L_{WA}$	8 - 18	-23	-13	-5	-3	-4	-6	-11	-19
$L_W$	8 - 18	+3	+3	+4	0	-4	-7	-12	-18
$L_{WA}$	20 - 36	-20	-12	-7	-5	-4	-5	-8	-15
$L_W$	20 - 36	+6	+4	+2	-2	-4	-6	-9	-14

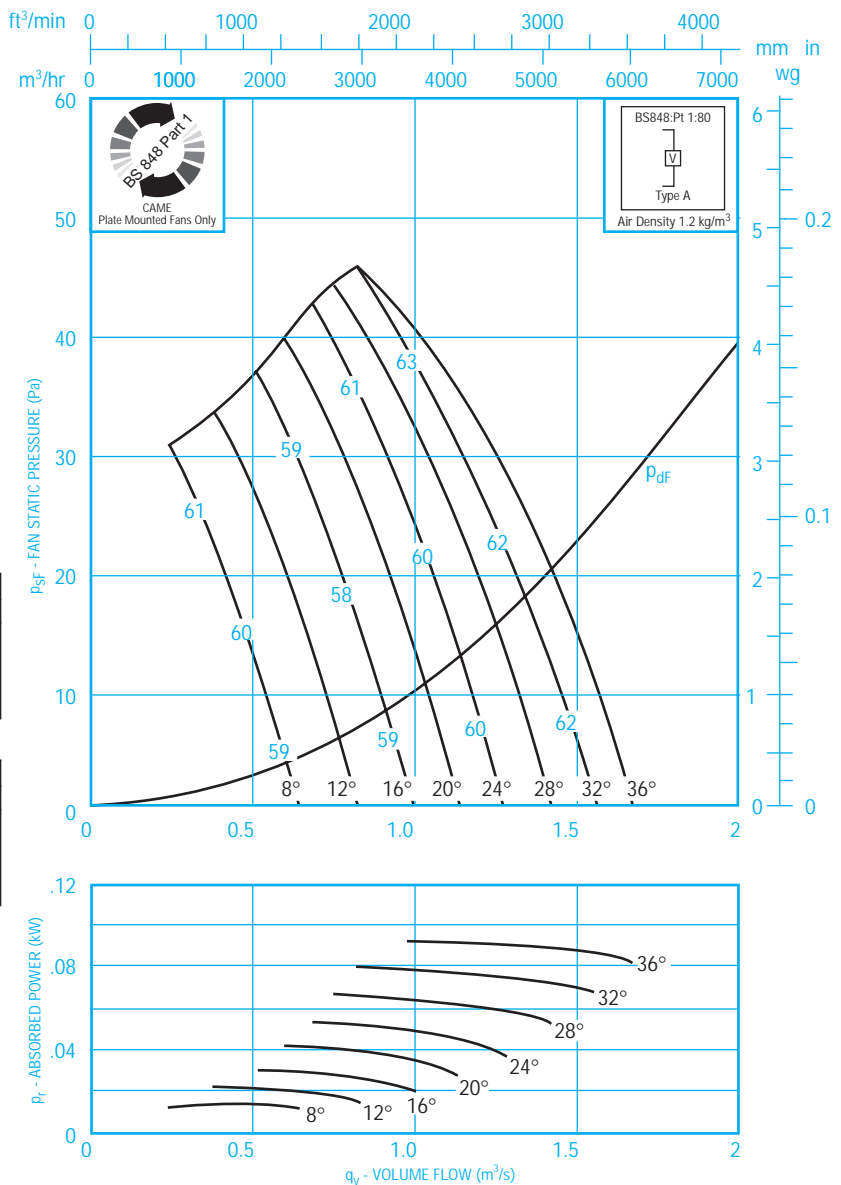

### Electrical Data

220-240 V / 50 Hz / 1  $\phi$

Chart No. 7

Motor	Fixed Speed				Speed Controllable					
	Pitch Angle (°)	Motor Rating (kW)	Full Load (A)	Starting Current (A)	Pitch Angle (°)	Motor Rating (kW)	Full Load (A)	Starting Current (A)	Speed Controller	
									Electronic	Auto-Transformer
BT5	20 - 28	0.7	0.8	1.2	20 - 26	0.065	0.9	1.3	ME1.1	MT1.1
BT9	30 - 36	0.11	1.1	1.9	28 - 34	0.09	1	1.7	ME1.3	MT1.5
CT5	-	-	-	-	36	0.13	1.3	2.1	ME1.3	MT1.5

380-420 V / 50 Hz / 3  $\phi$

Motor	Fixed Speed				Speed Controllable					
	Pitch Angle (°)	Motor Rating (kW)	Full Load (A)	Starting Current (A)	Pitch Angle (°)	Motor Rating (kW)	Full Load (A)	Starting Current (A)	Speed Control	
									Electronic	$\Delta/\Lambda$ * Pitch Angle
BT5	8 - 28	0.07	0.5	0.8	22 - 28	0.065	0.5	0.8	ME3.2S	-
BT9	30 - 36	0.11	0.6	1.1	30 - 34	0.09	0.5	0.9	ME3.2D	34
CT5	-	-	-	-	36	0.13	0.7	1.5	ME3.2D	-

\* By connecting these 3 phase motors in star ( $\Lambda$ ), a second speed will be obtained approximately 80% of the full speed at the angle shown. (A Woods two speed switch type MDS3.10 is available). For dimensions and weights of this fan please refer to pages 54 and 55.

# AEROFOIL CLIMAFAN



Fan Code: 56AC/8/6/...

560 mm 670 rev/min 6 Blades 50 Hz

## Performance Data

### BS 848 Pt 1 1980

Performance shown is specifically for non-ducted installations.

## Sound Data

### BS 848 Pt 2 1985

Single figures on performance curves, "A" weighted ( $L_{WA}$  re: 1 pW), derived from measurements taken in Woods laboratory specifically under non-ducted free field conditions. For sound power levels in eight octave bands, apply the following corrections to the overall level:

### Inlet Levels

	Pitch Angle	Frequency Hz							
		63	125	250	500	1K	2K	4K	8K
$L_{WA}$	8 - 18	-26	-14	-7	-5	-5	-10	-18	-24
$L_W$	8 - 18	0	+2	-2	-2	-5	-11	-19	-23
$L_{WA}$	20 - 36	-24	-14	-9	-5	-5	-8	-14	-20
$L_W$	20 - 36	+2	+2	0	-2	-5	-9	-15	-19

### Outlet Levels

	Pitch Angle	Frequency Hz							
		63	125	250	500	1K	2K	4K	8K
$L_{WA}$	8 - 18	-21	-11	-5	-3	-3	-7	-15	-20
$L_W$	8 - 18	+5	+5	+4	0	-3	-8	-16	-19
$L_{WA}$	20 - 36	-19	-10	-6	-3	-3	-6	-11	-17
$L_W$	20 - 36	+7	+6	+3	0	-3	-7	-12	-16

Three blade performance available. See chart number 7.

## Electrical Data

220-240 V / 50 Hz / 1  $\phi$

Motor	Fixed Speed				Speed Controllable					
	Pitch Angle (°)	Motor Rating (kW)	Full Load (A)	Starting Current (A)	Pitch Angle (°)	Motor Rating (kW)	Full Load (A)	Starting Current (A)	Speed Controller	
									Electronic	Auto-Transformer
BT9	20 - 28	0.11	1.1	1.9	20 - 24	0.09	1	1.7	ME1.3	MT1.5
CT5	30 - 36	0.16	1.5	2.5	26 - 32	0.13	1.3	2.1	ME1.3	MT1.5
CT9	-	-	-	-	34 - 36	0.18	1.6	2.6	ME1.3	MT1.5

380-420 V / 50 Hz / 3  $\phi$

Motor	Fixed Speed				Speed Controllable					
	Pitch Angle (°)	Motor Rating (kW)	Full Load (A)	Starting Current (A)	Pitch Angle (°)	Motor Rating (kW)	Full Load (A)	Starting Current (A)	Speed Control	
									Electronic	$\Delta/\Delta$ * Pitch Angle
BT5	8 - 18	0.07	0.5	0.8	14 - 18	0.065	0.5	0.8	ME3.2S	-
BT9	20 - 28	0.11	0.6	1.1	20 - 24	0.09	0.5	0.9	ME3.2D	24
CT5	30 - 36	0.16	0.8	1.5	26 - 32	0.13	0.7	1.5	ME3.2D	32

\* By connecting these 3 phase motors in star ( $\Delta$ ), a second speed will be obtained approximately 80% of the full speed at the angle shown. (A Woods two speed switch type MDS3.10 is available). For dimensions and weights of this fan please refer to pages 54 and 55.

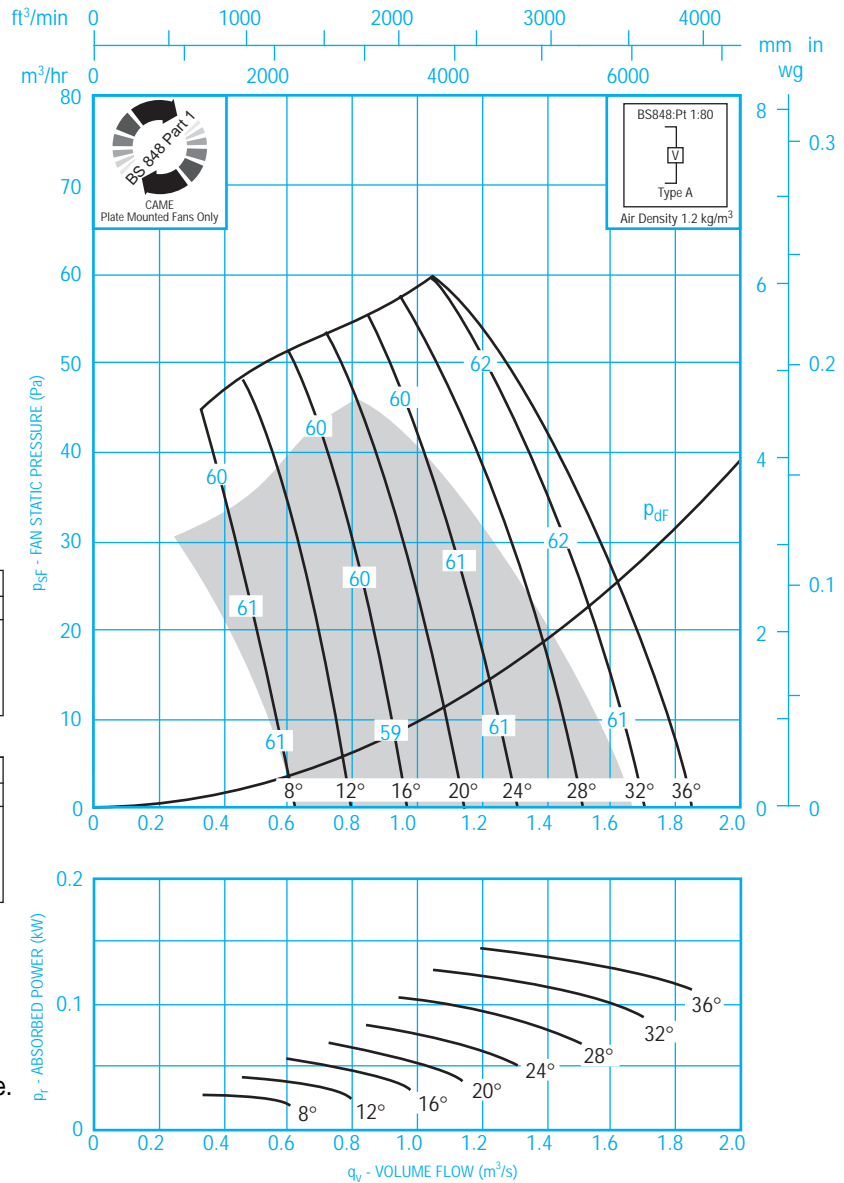

Chart No. 8



# AEROFOIL CLIMAFAN



## Fan Code: 56AC/6/3/...

## 560 mm 915 rev/min 3 Blades 50 Hz



### Performance Data

#### BS 848 Pt 1 1980

Performance shown is specifically for non-ducted installations.

### Sound Data

#### BS 848 Pt 2 1985

Single figures on performance curves are overall inlet sound power levels, "A" weighted ( $L_{WA}$  re: 1 pW), derived from measurements taken in Woods laboratory specifically under non-ducted free field conditions. For sound power levels in eight octave bands, apply the following corrections to the overall level:

#### Inlet Levels

	Pitch Angle	Frequency Hz							
		63	125	250	500	1K	2K	4K	8K
$L_{WA}$	8 - 18	-27	-16	-7	-5	-6	-9	-14	-22
$L_W$	8 - 18	-1	0	+2	-2	-6	-10	-15	-21
$L_{WA}$	20 - 36	-25	-15	-9	-6	-6	-7	-11	-18
$L_W$	20 - 36	+1	+1	0	-3	-6	-8	-12	-17

#### Outlet Levels

	Pitch Angle	Frequency Hz							
		63	125	250	500	1K	2K	4K	8K
$L_{WA}$	8 - 18	-23	-13	-5	-4	-4	-7	-12	-19
$L_W$	8 - 18	+3	+3	+4	-1	-4	-8	-13	-18
$L_{WA}$	20 - 36	-20	-12	-7	-5	-4	-5	-8	-14
$L_W$	20 - 36	+6	+4	+2	-2	-4	-6	-9	-13

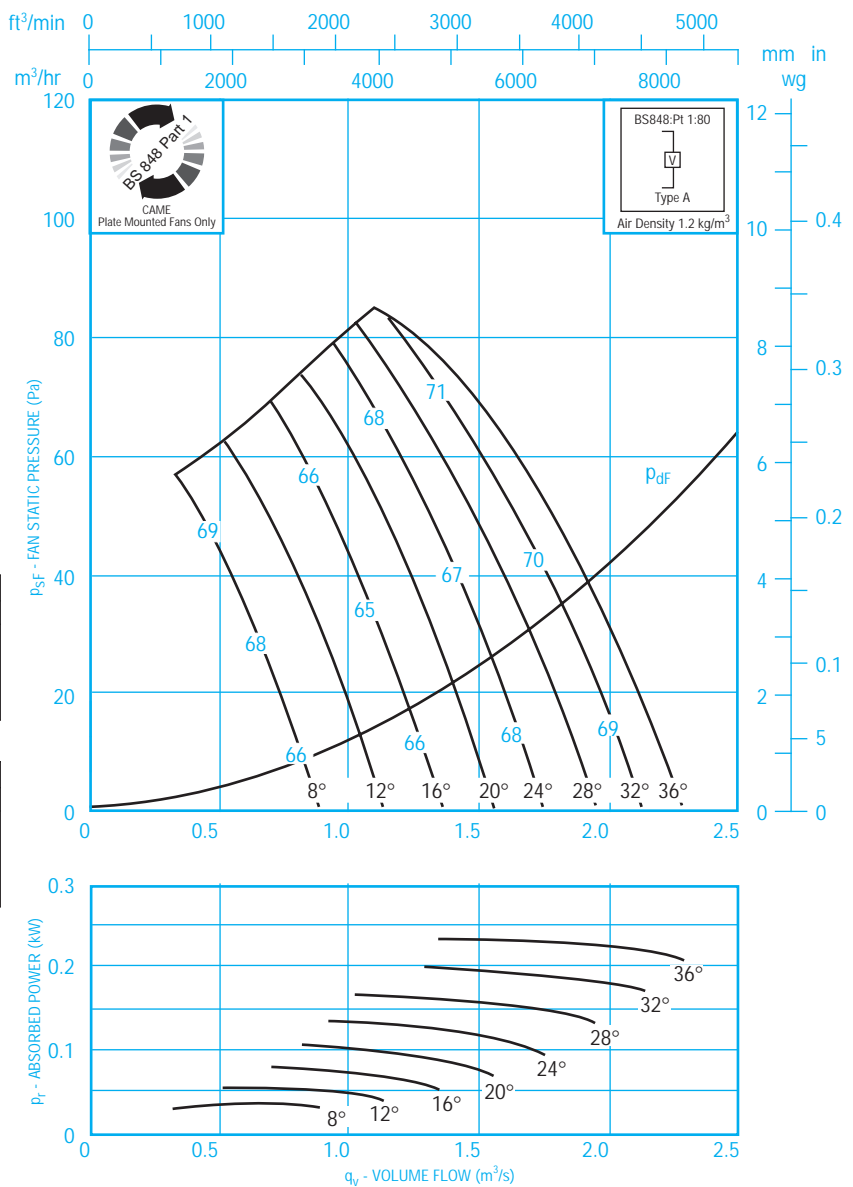

### Electrical Data

220-240 V / 50 Hz / 1  $\phi$

Chart No. 9

Motor	Fixed Speed				Speed Controllable					
	Pitch Angle (°)	Motor Rating (kW)	Full Load (A)	Starting Current (A)	Pitch Angle (°)	Motor Rating (kW)	Full Load (A)	Starting Current (A)	Speed Controller	
									Electronic	Auto-Transformer
BT5	10 - 22	0.12	1	1.6	12 - 16	0.09	0.8	1.6	ME1.1	MT1.1
BT9	24 - 30	0.19	1.5	2.8	22 - 24	0.14	1.2	2.8	ME1.3	MT1.5
CT5	36	0.37	2.9	4	-	-	-	-	-	-

380-420 V / 50 Hz / 3  $\phi$

Motor	Fixed Speed				Speed Controllable					
	Pitch Angle (°)	Motor Rating (kW)	Full Load (A)	Starting Current (A)	Pitch Angle (°)	Motor Rating (kW)	Full Load (A)	Starting Current (A)	Speed Control	
									Electronic	$\Delta/\Lambda$ * Pitch Angle
BT5	8 - 22	0.12	0.5	1.2	14 - 16	0.09	0.4	1.2	ME3.2D	16
BT9	24 - 30	0.19	0.7	1.8	18 - 24	0.14	0.6	1.8	ME3.2D	24
CT5	32 - 36	0.37	1.3	3.3	34 - 36	0.3	1.1	3.3	ME3.2D	-

\* By connecting these 3 phase motors in star ( $\Lambda$ ), a second speed will be obtained approximately 80% of the full speed at the angle shown. (A Woods two speed switch type MDS3.10 is available). For dimensions and weights of this fan please refer to pages 54 and 55.

# AEROFOIL CLIMAFAN



## Fan Code: 56AC/6/6/...

## 560 mm 900 rev/min 6 Blades 50 Hz

### Performance Data

#### BS 848 Pt 1 1980

Performance shown is specifically for non-ducted installations.

### Sound Data

#### BS 848 Pt 2 1985

Single figures on performance curves are overall inlet sound power levels, "A" weighted ( $L_{WA}$  re: 1 pW), derived from measurements taken in Woods laboratory specifically under non-ducted free field conditions. For sound power levels in eight octave bands, apply the following corrections to the overall level:

#### Inlet Levels

	Pitch Angle	Frequency Hz							
		63	125	250	500	1K	2K	4K	8K
$L_{WA}$	8 - 18	-31	-18	-8	-5	-5	-8	-15	-23
$L_W$	8 - 18	-5	-2	+1	-2	-5	-9	-16	-22
$L_{WA}$	20 - 36	-29	-17	-8	-6	-5	-7	-13	-20
$L_W$	20 - 36	-3	-1	+1	-3	-5	-8	-14	-19

#### Outlet Levels

	Pitch Angle	Frequency Hz							
		63	125	250	500	1K	2K	4K	8K
$L_{WA}$	8 - 18	-28	-13	-5	-3	-3	-6	-12	-20
$L_W$	8 - 18	-2	+3	+4	0	-3	-7	-13	-19
$L_{WA}$	20 - 36	-26	-11	-5	-3	-3	-5	-10	-17
$L_W$	20 - 36	0	+5	+4	0	-3	-6	-11	-16

Three blade performance available. See chart number 9.

### Electrical Data

220-240 V / 50 Hz / 1  $\phi$

Chart No. 10

Motor	Fixed Speed				Speed Controllable					
	Pitch Angle (°)	Motor Rating (kW)	Full Load (A)	Starting Current (A)	Pitch Angle (°)	Motor Rating (kW)	Full Load (A)	Starting Current (A)	Speed Controller	
									Electronic	Auto-Transformer
BT5	8 - 14	0.12	1	1.6	-	-	-	-	-	-
BT9	16 - 22	0.19	1.5	2.8	14	0.14	1.2	2.8	ME1.3	MT1.5
CT5	26 - 36	0.37	2.9	4	28 - 30	0.3	2.4	4	ME1.3	MT1.5

380-420 V / 50 Hz / 3  $\phi$

Motor	Fixed Speed				Speed Controllable					
	Pitch Angle (°)	Motor Rating (kW)	Full Load (A)	Starting Current (A)	Pitch Angle (°)	Motor Rating (kW)	Full Load (A)	Starting Current (A)	Speed Control	
									Electronic	$\Delta/\lambda$ * Pitch Angle
BT5	8 - 12	0.12	0.5	1.2	-	-	-	-	-	-
BT9	14 - 20	0.19	0.7	1.8	12 - 16	0.14	0.6	1.8	ME3.2D	16
CT5	22 - 36	0.37	1.3	3.3	26 - 30	0.3	1.1	3.3	ME3.2D	30

\* By connecting these 3 phase motors in star ( $\lambda$ ), a second speed will be obtained approximately 80% of the full speed at the angle shown. (A Woods two speed switch type MDS3.10 is available). For dimensions and weights of this fan please refer to pages 54 and 55.

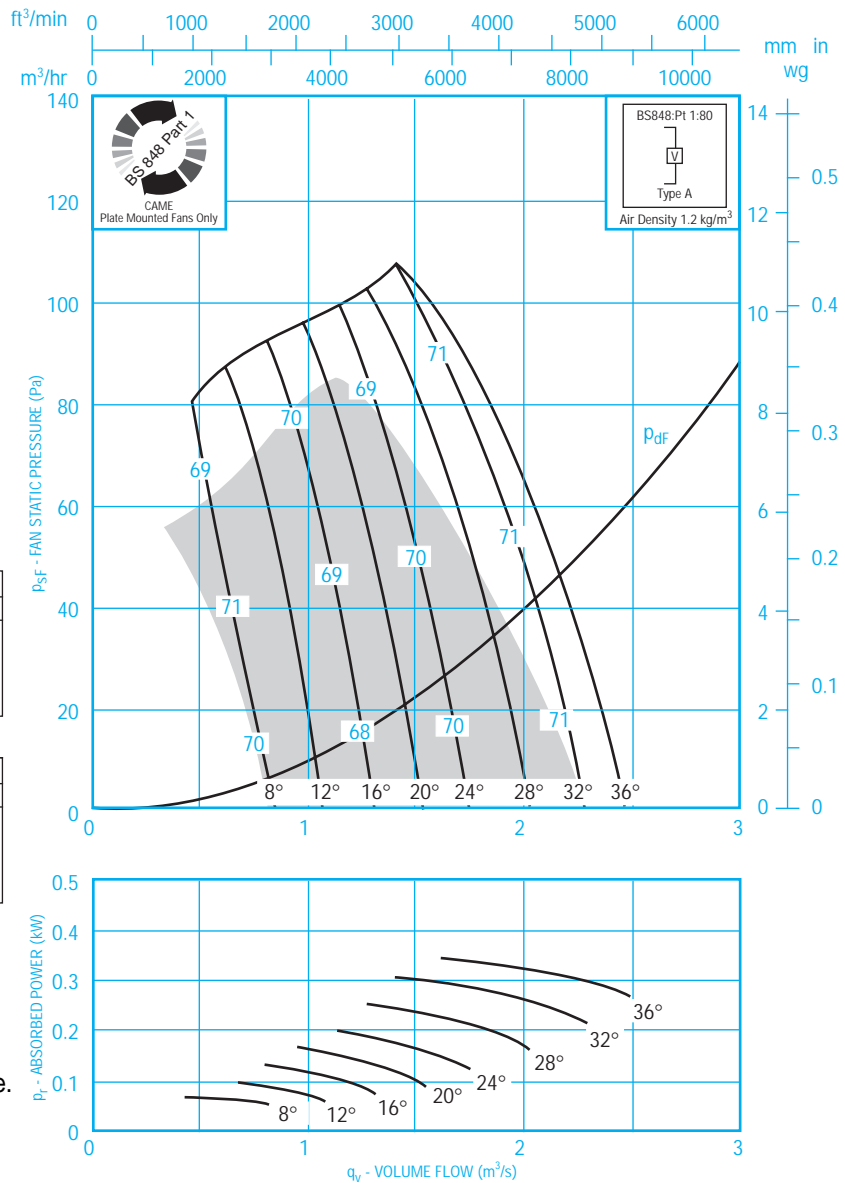

# AEROFOIL CLIMAFAN



## Fan Code: 56AC/4/3/...

## 560 mm 1420 rev/min 3 Blades 50 Hz



### Performance Data

#### BS 848 Pt 1 1980

Performance shown is specifically for non-ducted installations.

### Sound Data

#### BS 848 Pt 2 1985

Single figures on performance curves are overall inlet sound power levels, "A" weighted ( $L_{WA}$  re: 1 pW), derived from measurements taken in Woods laboratory specifically under non-ducted free field conditions. For sound power levels in eight octave bands, apply the following corrections to the overall level:

#### Inlet Levels

	Pitch Angle	Frequency Hz							
		63	125	250	500	1K	2K	4K	8K
$L_{WA}$	8 - 18	-30	-20	-10	-4	-6	-8	-12	-21
$L_W$	8 - 18	-4	-4	-1	-1	-6	-9	-13	-20
$L_{WA}$	20 - 36	-27	-18	-9	-5	-6	-8	-10	-16
$L_W$	20 - 36	-1	-2	0	-2	-6	-9	-11	-15

#### Outlet Levels

	Pitch Angle	Frequency Hz							
		63	125	250	500	1K	2K	4K	8K
$L_{WA}$	8 - 18	-25	-17	-8	-3	-4	-6	-10	-18
$L_W$	8 - 18	+1	-1	+1	0	-4	-7	-11	-17
$L_{WA}$	20 - 36	-22	-15	-8	-4	-4	-6	-7	-13
$L_W$	20 - 36	+4	+1	+1	-1	-4	-7	-8	-12

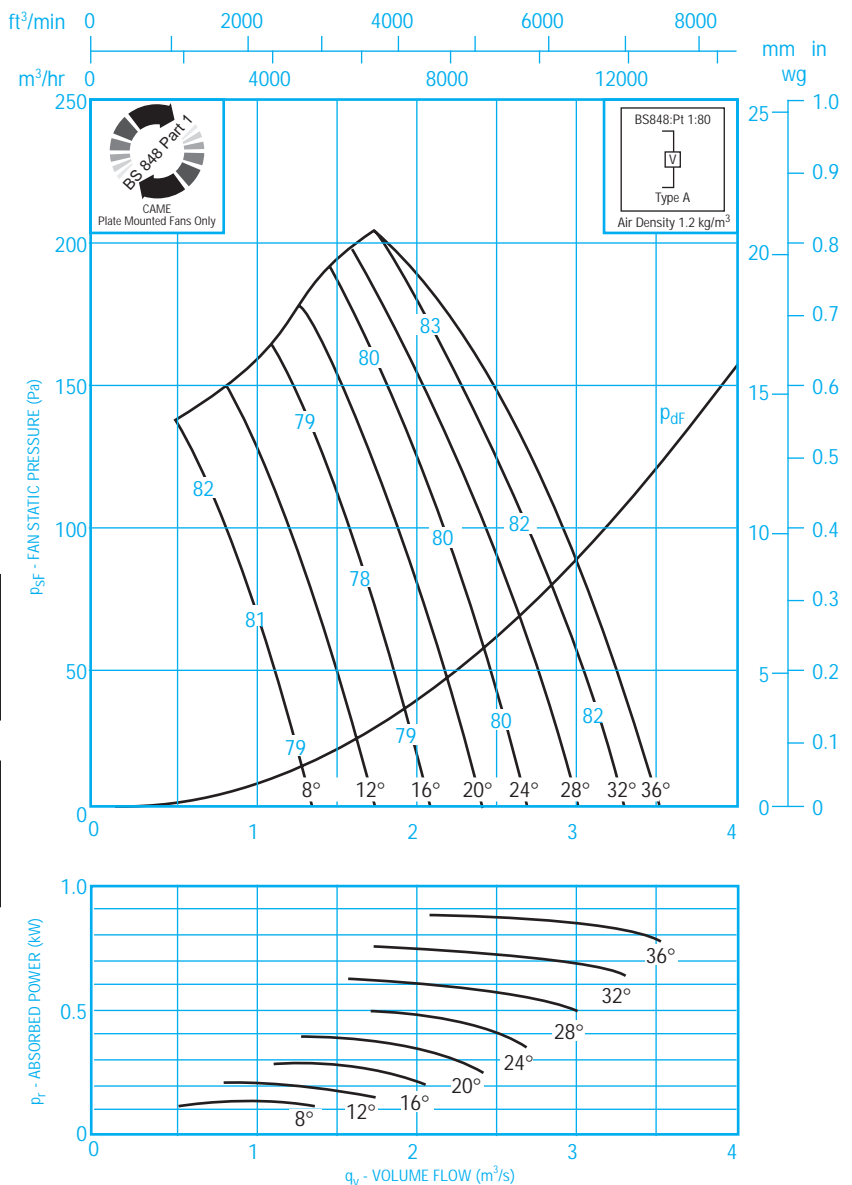

### Electrical Data

220-240 V / 50 Hz / 1  $\phi$

Chart No. 11

Motor	Fixed Speed				Speed Controllable					
	Pitch Angle (°)	Motor Rating (kW)	Full Load (A)	Starting Current (A)	Pitch Angle (°)	Motor Rating (kW)	Full Load (A)	Starting Current (A)	Speed Controller	
									Electronic	Auto-Transformer
BT9	16 - 18	0.39	2.7	5.3	12 - 16	0.3	2.1	5.3	ME1.3	MT1.5
CT5	22 - 30	0.7	4.4	9.5	24	0.55	3.7	9.5	ME1.6	MT1.5
CT9	-	-	-	-	32 - 36	0.9	5.8	19	ME1.6	MT1.8

380-420 V / 50 Hz / 3  $\phi$

Motor	Fixed Speed				Speed Controllable					
	Pitch Angle (°)	Motor Rating (kW)	Full Load (A)	Starting Current (A)	Pitch Angle (°)	Motor Rating (kW)	Full Load (A)	Starting Current (A)	Speed Control	
									Electronic	$\Delta/\Lambda$ * Pitch Angle
BT9	14 - 18	0.39	1.1	4.6	12 - 16	0.3	0.9	4.6	ME3.2D	16
CT5	20 - 30	0.71	1.9	6.5	22 - 26	0.58	1.7	6.5	ME3.2D	26
CT9	32 - 36	1.4	3.5	14	-	-	-	-	-	-

\* By connecting these 3 phase motors in star ( $\Lambda$ ), a second speed will be obtained approximately 80% of the full speed at the angle shown. (A Woods two speed switch type MDS3.10 is available). For dimensions and weights of this fan please refer to pages 54 and 55.

# AEROFOIL CLIMAFAN



## Fan Code: 56AC/4/6/...

## 560 mm 1420 rev/min 6 Blades 50 Hz

### Performance Data

#### BS 848 Pt 1 1980

Performance shown is specifically for non-ducted installations.

### Sound Data

#### BS 848 Pt 2 1985

Single figures on performance curves are overall inlet sound power levels, "A" weighted ( $L_{WA}$  re: 1 pW), derived from measurements taken in Woods laboratory specifically under non-ducted free field conditions. For sound power levels in eight octave bands, apply the following corrections to the overall level:

#### Inlet Levels

	Pitch Angle	Frequency Hz							
		63	125	250	500	1K	2K	4K	8K
$L_{WA}$	8 - 18	-35	-21	-13	-5	-5	-8	-12	-21
$L_W$	8 - 18	-9	-5	-4	-2	-5	-9	-13	-20
$L_{WA}$	20 - 36	-32	-18	-11	-6	-5	-6	-10	-18
$L_W$	20 - 36	-6	-2	-2	-3	-5	-7	-11	-17

#### Outlet Levels

	Pitch Angle	Frequency Hz							
		63	125	250	500	1K	2K	4K	8K
$L_{WA}$	8 - 18	-33	-16	-9	-2	-3	-6	-10	-18
$L_W$	8 - 18	-7	0	0	+1	-3	-7	-11	-17
$L_{WA}$	20 - 36	-29	-13	-7	-3	-3	-5	-8	-16
$L_W$	20 - 36	-3	+3	+2	0	-3	-6	-9	-15

Three blade performance available. See chart number 11.

### Electrical Data

220-240 V / 50 Hz / 1  $\phi$

Chart No. 12

Motor	Fixed Speed				Speed Controllable					
	Pitch Angle (°)	Motor Rating (kW)	Full Load (A)	Starting Current (A)	Pitch Angle (°)	Motor Rating (kW)	Full Load (A)	Starting Current (A)	Speed Controller	
									Electronic	Auto-Transformer
CT5	14 - 20	0.7	4.4	9.5	16	0.55	3.7	9.5	ME1.6	MT1.5
CT9	26 - 32	1.3	8.2	23	28 - 30	1.1	7.2	23	ME1.10	-
F2245	-	-	-	-	36	1.7	10	33	-	-

380-420 V / 50 Hz / 3  $\phi$

Motor	Fixed Speed				Speed Controllable					
	Pitch Angle (°)	Motor Rating (kW)	Full Load (A)	Starting Current (A)	Pitch Angle (°)	Motor Rating (kW)	Full Load (A)	Starting Current (A)	Speed Control	
									Electronic	$\Delta/\lambda$ * Pitch Angle
CT5	12 - 20	0.71	1.9	6.5	14 - 16	0.58	1.7	6.5	ME3.2D	16
CT9	22 - 34	1.4	3.5	14	26 - 30	1.15	3	11.4	ME3.2D	30
F2245	36	2.7	5.8	30	32 - 36	1.6	3.7	24	-	-

\* By connecting these 3 phase motors in star ( $\lambda$ ), a second speed will be obtained approximately 80% of the full speed at the angle shown. (A Woods two speed switch type MDS3.10 is available). For dimensions and weights of this fan please refer to pages 54 and 55.

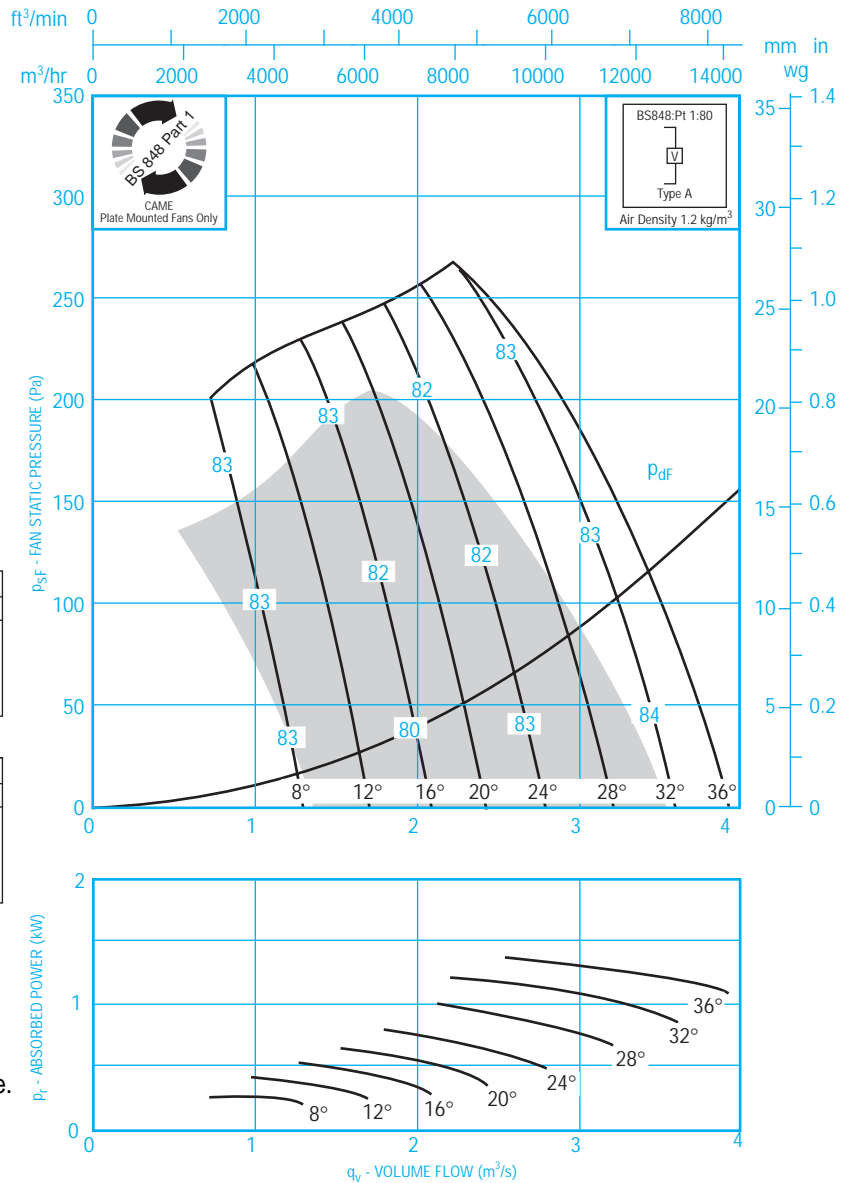

# AEROFOIL CLIMAFAN



## Fan Code: 63AC/8/3/...

## 630 mm 670 rev/min 3 Blades 50 Hz



### Performance Data

#### BS 848 Pt 1 1980

Performance shown is specifically for non-ducted installations.

### Sound Data

#### BS 848 Pt 2 1985

Single figures on performance curves are overall inlet sound power levels, "A" weighted ( $L_{WA}$  re: 1 pW), derived from measurements taken in Woods laboratory specifically under non-ducted free field conditions. For sound power levels in eight octave bands, apply the following corrections to the overall level:

#### Inlet Levels

	Pitch Angle	Frequency Hz							
		63	125	250	500	1K	2K	4K	8K
$L_{WA}$	8 - 18	-27	-16	-7	-4	-6	-10	-15	-22
$L_W$	8 - 18	-1	0	+2	-1	-6	-11	-16	-21
$L_{WA}$	20 - 36	-25	-15	-8	-5	-6	-9	-13	-17
$L_W$	20 - 36	+1	+1	+1	-2	-6	-10	-14	-16

#### Outlet Levels

	Pitch Angle	Frequency Hz							
		63	125	250	500	1K	2K	4K	8K
$L_{WA}$	8 - 18	-20	-13	-5	-2	-4	-8	-13	-19
$L_W$	8 - 18	+6	+3	+4	+1	-4	-9	-14	-18
$L_{WA}$	20 - 36	-18	-11	-5	-3	-4	-7	-11	-14
$L_W$	20 - 36	+8	+5	+4	0	-4	-8	-12	-13

Extra performance only from plate mounted fans.

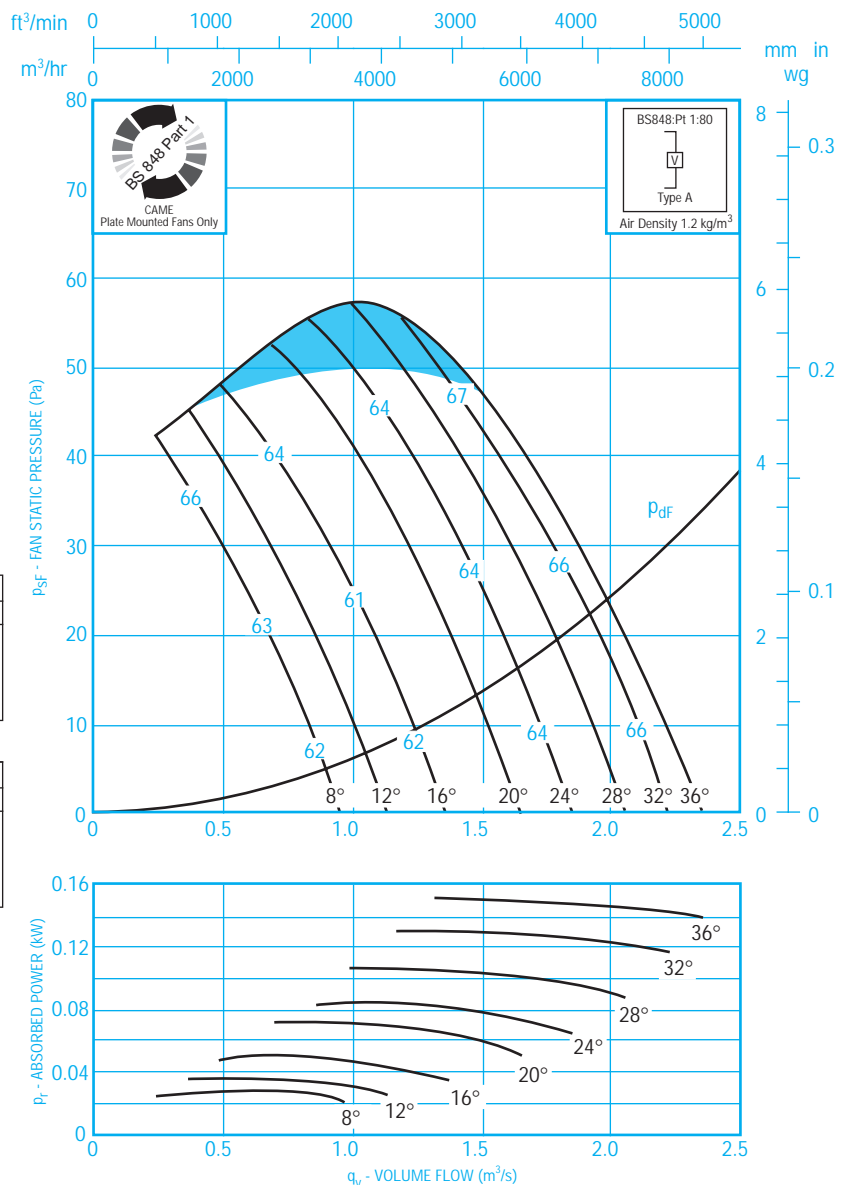

### Electrical Data

220-240 V / 50 Hz / 1  $\phi$

Chart No. 13

Motor	Fixed Speed				Speed Controllable					
	Pitch Angle (°)	Motor Rating (kW)	Full Load (A)	Starting Current (A)	Pitch Angle (°)	Motor Rating (kW)	Full Load (A)	Starting Current (A)	Speed Controller	
									Electronic	Auto-Transformer
BT9	20 - 28	0.11	1.1	1.9	20 - 24	0.09	1	1.7	ME1.3	MT1.5
CT5	30 - 36	0.16	1.5	2.1	26 - 30	0.13	1.3	2.1	ME1.3	MT1.5
-	-	-	-	-	-	-	-	-	-	-

380-420 V / 50 Hz / 3  $\phi$

Motor	Fixed Speed				Speed Controllable					
	Pitch Angle (°)	Motor Rating (kW)	Full Load (A)	Starting Current (A)	Pitch Angle (°)	Motor Rating (kW)	Full Load (A)	Starting Current (A)	Speed Control	
									Electronic	$\Delta/\Lambda$ * Pitch Angle
BT9	8 - 28	0.11	0.6	1.1	20 - 24	0.09	0.5	0.9	ME3.2D	24
CT5	30 - 34	0.16	0.8	1.5	26 - 30	0.13	0.7	1.5	ME3.2D	30
CT9	36	0.3	1.4	2.6	-	-	-	-	-	-

\* By connecting these 3 phase motors in star ( $\Lambda$ ), a second speed will be obtained approximately 80% of the full speed at the angle shown. (A Woods two speed switch type MDS3.10 is available). For dimensions and weights of this fan please refer to pages 54 and 55.



# AEROFOIL CLIMAFAN



## Fan Code: 63AC/8/6/...

## 630 mm 680 rev/min 6 Blades 50 Hz

### Performance Data

#### BS 848 Pt 1 1980

Performance shown is specifically for non-ducted installations.

### Sound Data

#### BS 848 Pt 2 1985

Single figures on performance curves are overall inlet sound power levels, "A" weighted ( $L_{WA}$  re: 1 pW), derived from measurements taken in Woods laboratory specifically under non-ducted free field conditions. For sound power levels in eight octave bands, apply the following corrections to the overall level:

#### Inlet Levels

	Pitch Angle	Frequency Hz							
		63	125	250	500	1K	2K	4K	8K
$L_{WA}$	8 - 18	-29	-17	-8	-4	-6	-9	-17	-23
$L_W$	8 - 18	-3	-1	+1	-1	-6	-10	-18	-22
$L_{WA}$	20 - 36	-25	-15	-9	-5	-5	-9	-13	-17
$L_W$	20 - 36	+1	+1	0	-2	-5	-10	-14	-16

#### Outlet Levels

	Pitch Angle	Frequency Hz							
		63	125	250	500	1K	2K	4K	8K
$L_{WA}$	8 - 18	-21	-10	-4	-2	-4	-7	-14	-20
$L_W$	8 - 18	+5	+6	+5	+1	-4	-8	-15	-19
$L_{WA}$	20 - 36	-18	-9	-5	-2	-3	-7	-11	-13
$L_W$	20 - 36	+8	+7	+4	+1	-3	-8	-12	-12

Extra performance only from plate mounted fans.

Three blade performance available. See chart number 13.

### Electrical Data

220-240 V / 50 Hz / 1  $\phi$

Chart No. 14

Motor	Fixed Speed				Speed Controllable					
	Pitch Angle (°)	Motor Rating (kW)	Full Load (A)	Starting Current (A)	Pitch Angle (°)	Motor Rating (kW)	Full Load (A)	Starting Current (A)	Speed Controller	
									Electronic	Auto-Transformer
BT9	10 - 16	0.11	1.1	1.9	10 - 12	0.09	1	1.7	ME1.3	MT1.5
CT5	18 - 22	0.16	1.5	2.5	16 - 18	0.13	1.3	2.1	ME1.3	MT1.5
CT9	28 - 36	0.3	2.7	3.5	28 - 32	0.25	2.3	3.4	ME1.6	MT1.5

380-420 V / 50 Hz / 3  $\phi$

Motor	Fixed Speed				Speed Controllable					
	Pitch Angle (°)	Motor Rating (kW)	Full Load (A)	Starting Current (A)	Pitch Angle (°)	Motor Rating (kW)	Full Load (A)	Starting Current (A)	Speed Control	
									Electronic	$\Delta/\Delta$ * Pitch Angle
BT9	8 - 16	0.11	0.6	1.1	10 - 12	0.09	0.5	0.9	ME3.2D	12
CT5	18 - 22	0.16	0.8	1.5	14 - 18	0.13	0.7	1.5	ME3.2D	18
CT9	24 - 36	0.3	1.4	2.6	26 - 32	0.25	1.2	2.6	ME3.2D	32

\* By connecting these 3 phase motors in star ( $\lambda$ ), a second speed will be obtained approximately 80% of the full speed at the angle shown. (A Woods two speed switch type MDS3.10 is available). For dimensions and weights of this fan please refer to pages 54 and 55.

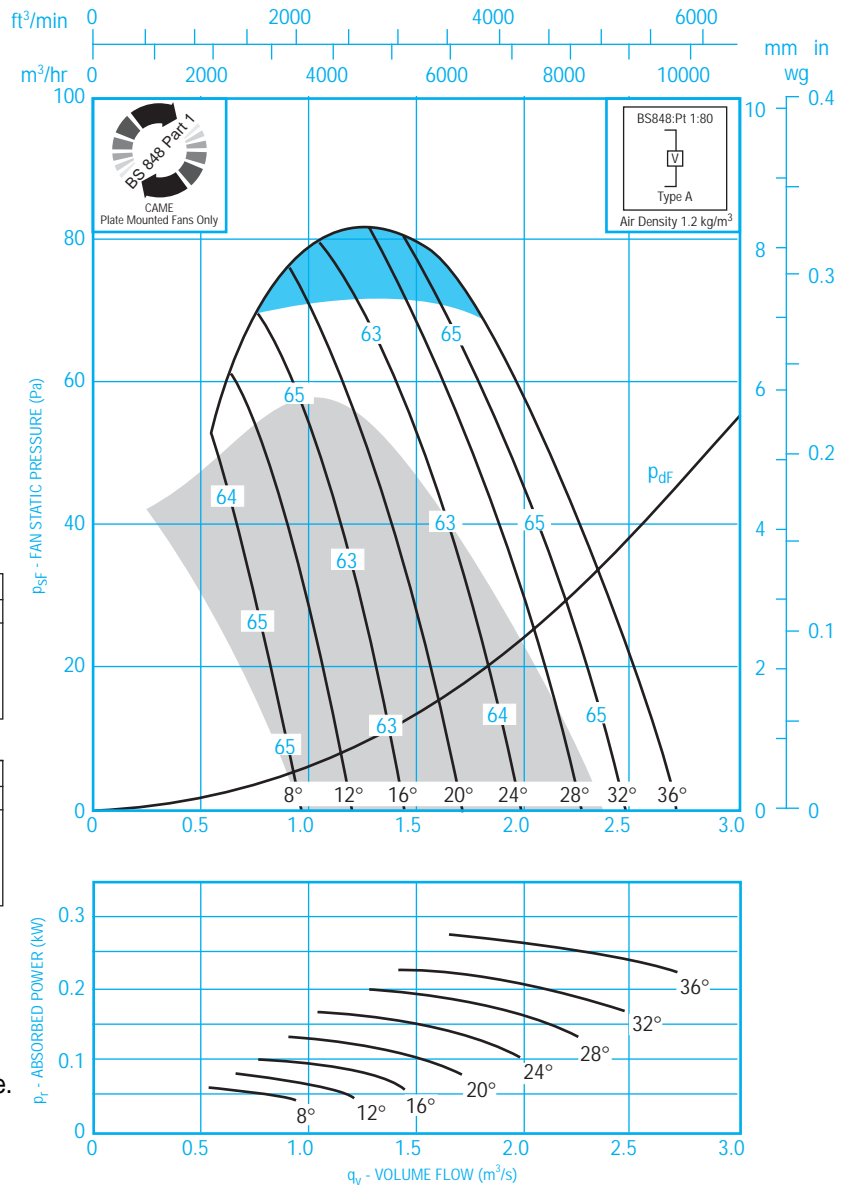

# AEROFOIL CLIMAFAN



## Fan Code: 63AC/6/3/...

## 630 mm 900 rev/min 3 Blades 50 Hz



### Performance Data

#### BS 848 Pt 1 1980

Performance shown is specifically for non-ducted installations.

### Sound Data

#### BS 848 Pt 2 1985

Single figures on performance curves are overall inlet sound power levels, "A" weighted ( $L_{WA}$  re: 1 pW), derived from measurements taken in Woods laboratory specifically under non-ducted free field conditions. For sound power levels in eight octave bands, apply the following corrections to the overall level:

#### Inlet Levels

	Pitch Angle	Frequency Hz							
		63	125	250	500	1K	2K	4K	8K
$L_{WA}$	8 - 18	-27	-16	-7	-4	-6	-10	-15	-22
$L_W$	8 - 18	-1	0	+2	-1	-6	-11	-16	-21
$L_{WA}$	20 - 36	-25	-15	-8	-5	-6	-9	-13	-17
$L_W$	20 - 36	+1	+1	+1	-2	-6	-10	-14	-16

#### Outlet Levels

	Pitch Angle	Frequency Hz							
		63	125	250	500	1K	2K	4K	8K
$L_{WA}$	8 - 18	-20	-13	-5	-2	-4	-8	-13	-19
$L_W$	8 - 18	+6	+3	+4	+1	-4	-9	-14	-18
$L_{WA}$	20 - 36	-18	-11	-5	-3	-4	-7	-11	-14
$L_W$	20 - 36	+8	+5	+4	0	-4	-8	-12	-13

Extra performance only from plate mounted fans.

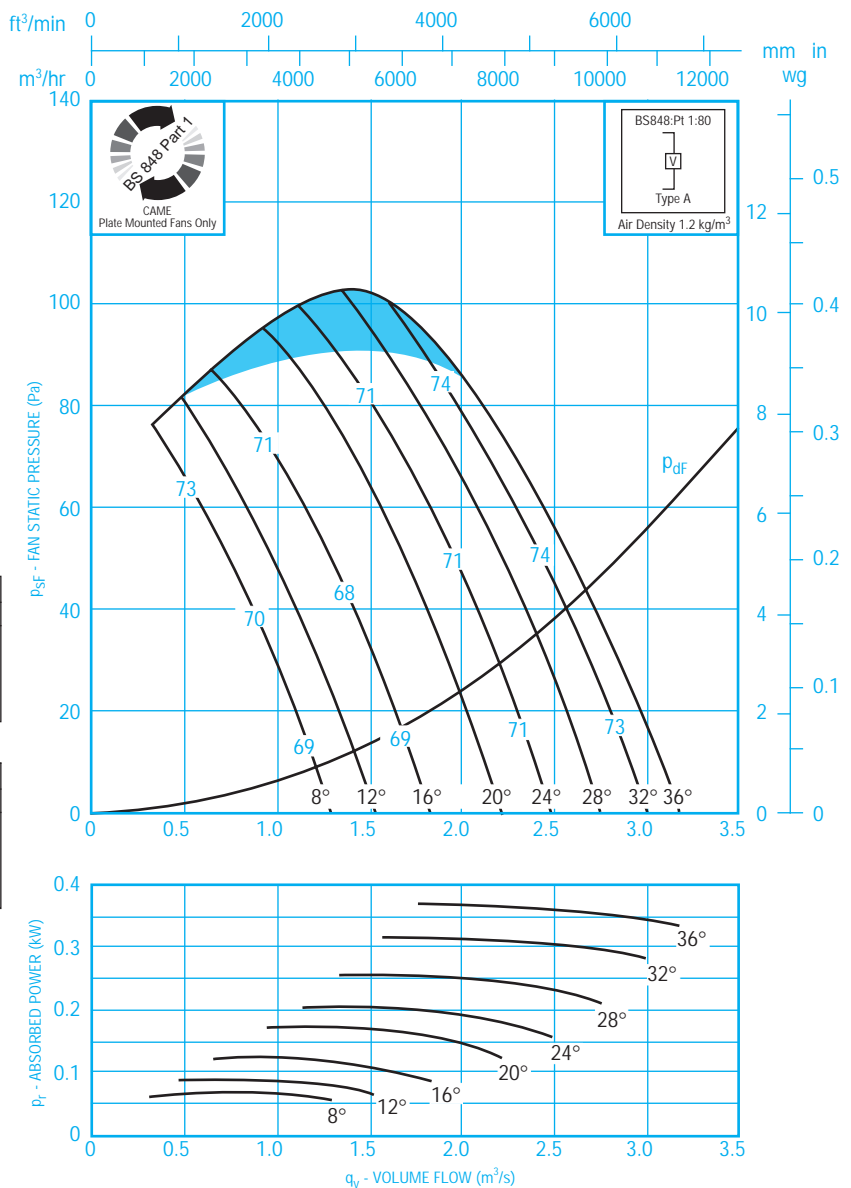

### Electrical Data

220-240 V / 50 Hz / 1  $\phi$

Chart No. 15

Motor	Fixed Speed				Speed Controllable					
	Pitch Angle (°)	Motor Rating (kW)	Full Load (A)	Starting Current (A)	Pitch Angle (°)	Motor Rating (kW)	Full Load (A)	Starting Current (A)	Speed Controller	
									Electronic	Auto-Transformer
BT9	16 - 20	0.19	1.5	2.8	10 - 12	0.14	1.2	2.8	ME1.3	MT1.5
CT5	26 - 34	0.37	2.9	4	28 - 30	0.3	2.4	4	ME1.3	MT1.5
-	-	-	-	-	-	-	-	-	-	-

380-420 V / 50 Hz / 3  $\phi$

Motor	Fixed Speed				Speed Controllable					
	Pitch Angle (°)	Motor Rating (kW)	Full Load (A)	Starting Current (A)	Pitch Angle (°)	Motor Rating (kW)	Full Load (A)	Starting Current (A)	Speed Control	
									Electronic	$\Delta/\Lambda$ * Pitch Angle
BT9	8 - 20	0.19	0.7	1.8	12 - 16	0.14	0.6	1.8	ME3.2D	16
CT5	22 - 34	0.37	1.3	3.3	26 - 30	0.3	1.1	3.3	ME3.2D	30
CT9	36	0.68	2.2	7.5	-	-	-	-	-	-

\* By connecting these 3 phase motors in star ( $\Lambda$ ), a second speed will be obtained approximately 80% of the full speed at the angle shown. (A Woods two speed switch type MDS3.10 is available). For dimensions and weights of this fan please refer to pages 54 and 55.

# AEROFOIL CLIMAFAN



## Fan Code: 63AC/6/6/...

## 630 mm 900 rev/min 6 Blades 50 Hz

### Performance Data

#### BS 848 Pt 1 1980

Performance shown is specifically for non-ducted installations.

### Sound Data

#### BS 848 Pt 2 1985

Single figures on performance curves are overall inlet sound power levels, "A" weighted ( $L_{WA}$  re: 1 pW), derived from measurements taken in Woods laboratory specifically under non-ducted free field conditions. For sound power levels in eight octave bands, apply the following corrections to the overall level:

#### Inlet Levels

	Pitch Angle	Frequency Hz							
		63	125	250	500	1K	2K	4K	8K
$L_{WA}$	8 - 18	-34	-21	-11	-5	-5	-9	-14	-22
$L_W$	8 - 18	-8	-5	-2	-2	-5	-10	-15	-21
$L_{WA}$	20 - 36	-29	-17	-10	-5	-5	-8	-13	-18
$L_W$	20 - 36	-3	-1	-1	-2	-5	-9	-14	-17

#### Outlet Levels

	Pitch Angle	Frequency Hz							
		63	125	250	500	1K	2K	4K	8K
$L_{WA}$	8 - 18	-30	-13	-5	-2	-3	-7	-12	-19
$L_W$	8 - 18	-4	+3	+4	+1	-3	-8	-13	-18
$L_{WA}$	20 - 36	-25	-10	-3	-2	-3	-6	-11	-15
$L_W$	20 - 36	+1	+6	+6	+1	-3	-7	-12	-14

Extra performance only from plate mounted fans.

Three blade performance available. See chart number 15.

### Electrical Data

220-240 V / 50 Hz / 1  $\phi$

Chart No. 16

Motor	Fixed Speed				Speed Controllable					
	Pitch Angle (°)	Motor Rating (kW)	Full Load (A)	Starting Current (A)	Pitch Angle (°)	Motor Rating (kW)	Full Load (A)	Starting Current (A)	Speed Controller	
									Electronic	Auto-Transformer
BT9	8 - 10	0.19	1.5	2.8	-	-	-	-	-	-
CT5	16 - 22	0.37	2.9	4	16 - 18	0.3	2.4	4	ME1.3	MT1.5
CT9	30 - 36	0.68	5.2	6.5	30	0.52	4	9.2	ME1.6	MT1.8

380-420 V / 50 Hz / 3  $\phi$

Motor	Fixed Speed				Speed Controllable					
	Pitch Angle (°)	Motor Rating (kW)	Full Load (A)	Starting Current (A)	Pitch Angle (°)	Motor Rating (kW)	Full Load (A)	Starting Current (A)	Speed Control	
									Electronic	$\Delta/\lambda$ * Pitch Angle
BT9	8	0.19	0.7	1.8	-	-	-	-	-	-
CT5	10 - 22	0.37	1.3	3.3	14 - 18	0.3	1.1	3.3	ME3.2D	18
CT9	24 - 36	0.68	2.2	7.5	26 - 30	0.52	1.7	7.5	ME3.2D	30

\* By connecting these 3 phase motors in star ( $\lambda$ ), a second speed will be obtained approximately 80% of the full speed at the angle shown. (A Woods two speed switch type MDS3.10 is available). For dimensions and weights of this fan please refer to pages 54 and 55.

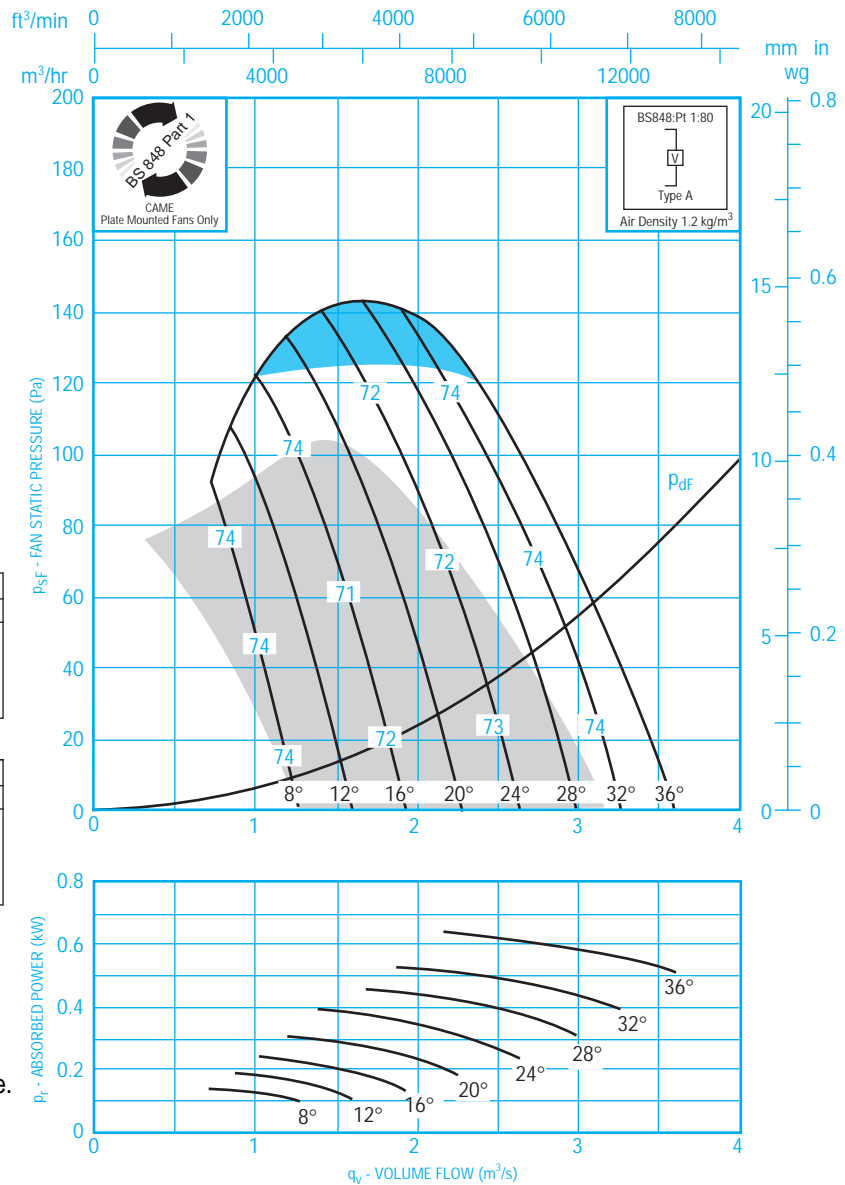

# AEROFOIL CLIMAFAN



## Fan Code: 63AC/4/3/...

## 630 mm 1420 rev/min 3 Blades 50 Hz



### Performance Data

#### BS 848 Pt 1 1980

Performance shown is specifically for non-ducted installations.

### Sound Data

#### BS 848 Pt 2 1985

Single figures on performance curves are overall inlet sound power levels, "A" weighted ( $L_{WA}$  re: 1 pW), derived from measurements taken in Woods laboratory specifically under non-ducted free field conditions. For sound power levels in eight octave bands, apply the following corrections to the overall level:

#### Inlet Levels

	Pitch Angle	Frequency Hz							
		63	125	250	500	1K	2K	4K	8K
$L_{WA}$	8 - 18	-30	-21	-12	-4	-5	-9	-13	-21
$L_W$	8 - 18	-4	-5	-3	-1	-5	-10	-14	-20
$L_{WA}$	20 - 36	-27	-18	-10	-5	-5	-8	-12	-18
$L_W$	20 - 36	-1	-2	-1	-2	-5	-9	-13	-17

#### Outlet Levels

	Pitch Angle	Frequency Hz							
		63	125	250	500	1K	2K	4K	8K
$L_{WA}$	8 - 18	-23	-18	-9	-2	-3	-7	-11	-19
$L_W$	8 - 18	+3	-2	0	+1	-3	-8	-12	-18
$L_{WA}$	20 - 36	-20	-15	-7	-2	-3	-6	-10	-16
$L_W$	20 - 36	+6	+1	+2	+1	-3	-7	-11	-15



Extra performance only from plate mounted fans.

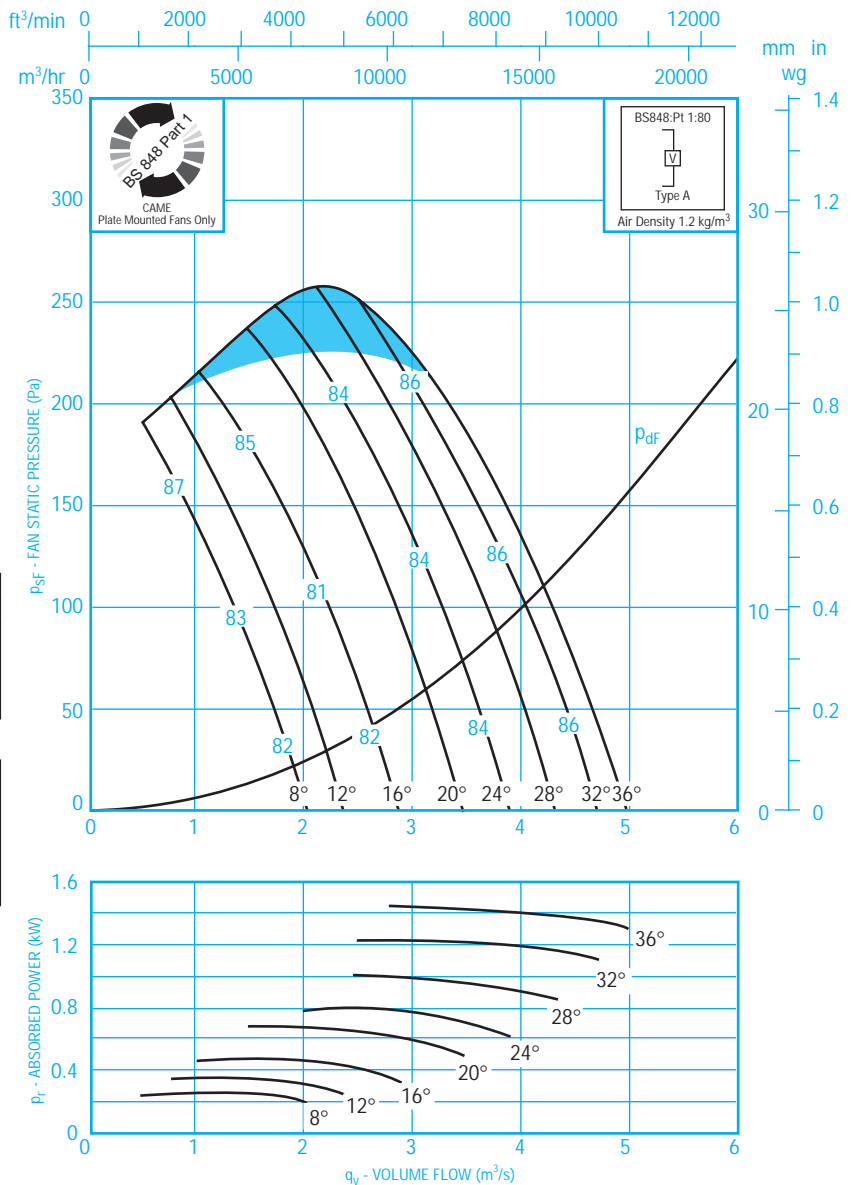

### Electrical Data

220-240 V / 50 Hz / 1  $\phi$

Chart No. 17

Motor	Fixed Speed				Speed Controllable						
	Pitch Angle (°)	Motor Rating (kW)	Full Load (A)	Starting Current (A)	Pitch Angle (°)	Motor Rating (kW)	Full Load (A)	Starting Current (A)	Speed Controller		
									Electronic	Auto-Transformer	
CT5	14 - 20	0.7	4.4	9.5	16	0.55	3.7	9.5	ME1.6	MT1.5	
CT9	26 - 32	1.3	8.2	23	28	1.1	7.2	23	ME1.10	-	
F2245	36	2	11	35	36	1.7	10	33	-	-	

380-420 V / 50 Hz / 3  $\phi$

Motor	Fixed Speed				Speed Controllable						
	Pitch Angle (°)	Motor Rating (kW)	Full Load (A)	Starting Current (A)	Pitch Angle (°)	Motor Rating (kW)	Full Load (A)	Starting Current (A)	Speed Control		
									Electronic	$\Delta/\Lambda$ * Pitch Angle	
CT5	12 - 20	0.71	1.9	6.5	12 - 16	0.58	1.7	6.5	ME3.2D	16	
CT9	22 - 34	1.4	3.5	14	26 - 30	1.15	3	11.4	ME3.2D	30	
F2245	36	2.7	5.8	30	-	-	-	-	-	-	

\* By connecting these 3 phase motors in star ( $\Lambda$ ), a second speed will be obtained approximately 80% of the full speed at the angle shown. (A Woods two speed switch type MDS3.10 is available). For dimensions and weights of this fan please refer to pages 54 and 55.

# AEROFOIL CLIMAFAN



## Fan Code: 63AC/4/6/...

## 630 mm 1420 rev/min 6 Blades 50 Hz

### Performance Data

#### BS 848 Pt 1 1980

Performance shown is specifically for non-ducted installations.

### Sound Data

#### BS 848 Pt 2 1985

Single figures on performance curves are overall inlet sound power levels, "A" weighted ( $L_{WA}$  re: 1 pW), derived from measurements taken in Woods laboratory specifically under non-ducted free field conditions. For sound power levels in eight octave bands, apply the following corrections to the overall level:

#### Inlet Levels

	Pitch Angle	Frequency Hz							
		63	125	250	500	1K	2K	4K	8K
$L_{WA}$	8 - 18	-37	-23	-15	-6	-4	-7	-11	-20
$L_W$	8 - 18	-11	-7	-6	-3	-4	-8	-12	-19
$L_{WA}$	20 - 36	-32	-18	-12	-6	-4	-6	-11	-18
$L_W$	20 - 36	-6	-2	-3	-3	-4	-7	-12	-17

#### Outlet Levels

	Pitch Angle	Frequency Hz							
		63	125	250	500	1K	2K	4K	8K
$L_{WA}$	8 - 18	-34	-15	-9	-1	-1	-5	-9	-18
$L_W$	8 - 18	-8	+1	0	+2	-1	-6	-10	-17
$L_{WA}$	20 - 36	-29	-11	-6	-2	-1	-5	-9	-15
$L_W$	20 - 36	-3	+5	+3	+1	-1	-6	-10	-14

Extra performance only from plate mounted fans.

Three blade performance available. See chart number 17

### Electrical Data

220-240 V / 50 Hz / 1  $\phi$

Chart No. 18

Motor	Fixed Speed				Speed Controllable						
	Pitch Angle (°)	Motor Rating (kW)	Full Load (A)	Starting Current (A)	Pitch Angle (°)	Motor Rating (kW)	Full Load (A)	Starting Current (A)	Speed Controller		
									Electronic	Auto-Transformer	
CT9	16 - 20	1.3	8.2	23	12	1.1	7.2	23	ME1.10	-	
F2245	24 - 30	2	11	35	24 - 26	1.7	10	33	-	-	
F2249	34 - 36	3.2	18	62	-	-	-	-	-	-	

380-420 V / 50 Hz / 3  $\phi$

Motor	Fixed Speed				Speed Controllable						
	Pitch Angle (°)	Motor Rating (kW)	Full Load (A)	Starting Current (A)	Pitch Angle (°)	Motor Rating (kW)	Full Load (A)	Starting Current (A)	Speed Control		
									Electronic	$\Delta/\Lambda$ * Pitch Angle	
CT5	8	0.71	1.9	6.5	-	-	-	-	-	-	
CT9	10 - 22	1.4	3.5	14	16 - 18	1.15	3	11.4	ME3.2D	18	
F2245	24 - 36	2.7	5.8	30	26 - 30	2.1	4.7	30	-	30	

\* By connecting these 3 phase motors in star ( $\Lambda$ ), a second speed will be obtained approximately 80% of the full speed at the angle shown. (A Woods two speed switch type MDS3.10 is available). For dimensions and weights of this fan please refer to pages 54 and 55.

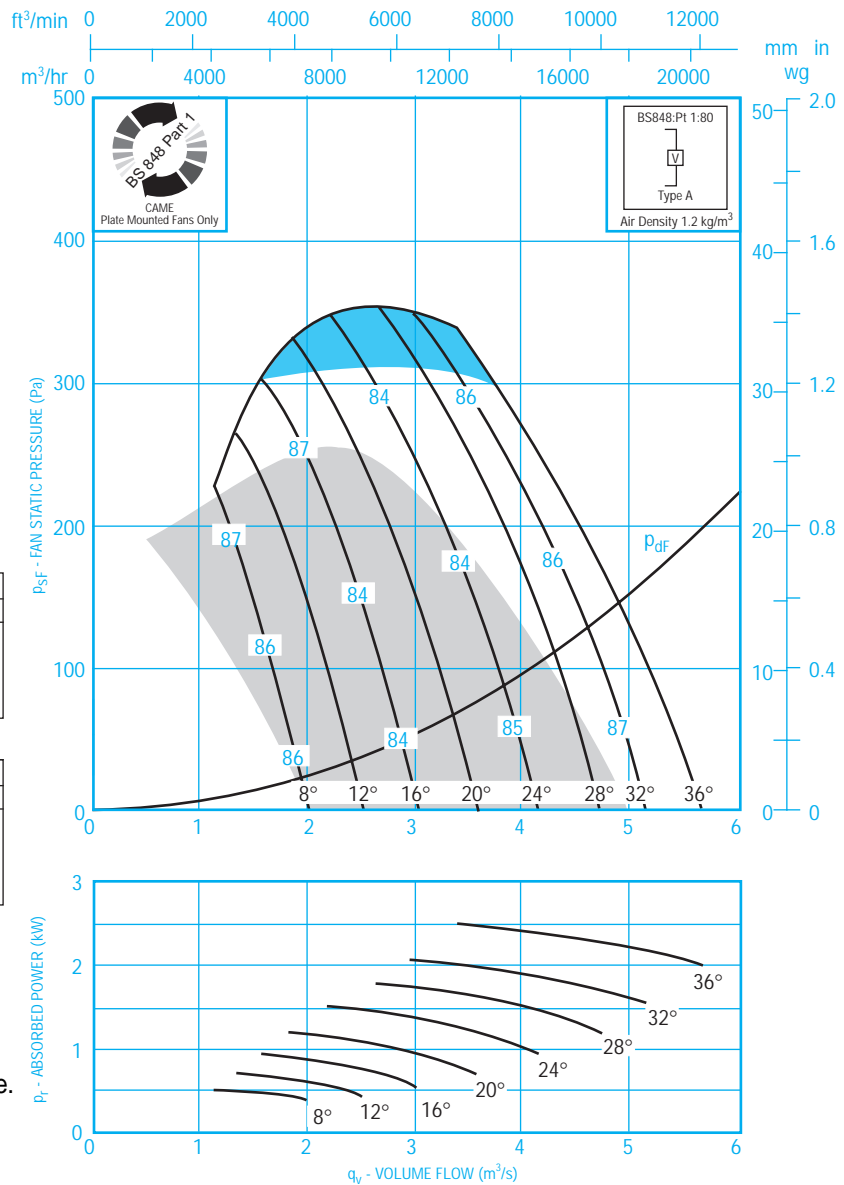



# AEROFOIL CLIMAFAN



## Fan Code: 71AC/8/3/...

## 710 mm 680 rev/min 3 Blades 50 Hz



### Performance Data

#### BS 848 Pt 1 1980

Performance shown is specifically for non-ducted installations.

### Sound Data

#### BS 848 Pt 2 1985

Single figures on performance curves are overall inlet sound power levels, "A" weighted ( $L_{WA}$  re: 1 pW), derived from measurements taken in Woods laboratory specifically under non-ducted free field conditions. For sound power levels in eight octave bands, apply the following corrections to the overall level:

#### Inlet Levels

	Pitch Angle	Frequency Hz							
		63	125	250	500	1K	2K	4K	8K
$L_{WA}$	8 - 18	-28	-16	-7	-5	-6	-9	-14	-21
$L_W$	8 - 18	-2	0	+2	-2	-6	-10	-15	-20
$L_{WA}$	20 - 32	-24	-15	-8	-6	-6	-8	-11	-16
$L_W$	20 - 32	+2	+1	+1	-3	-6	-9	-12	-15

#### Outlet Levels

	Pitch Angle	Frequency Hz							
		63	125	250	500	1K	2K	4K	8K
$L_{WA}$	8 - 18	-21	-13	-5	-3	-4	-7	-11	-18
$L_W$	8 - 18	+5	+3	+4	0	-4	-8	-12	-17
$L_{WA}$	20 - 32	-18	-11	-6	-4	-4	-6	-8	-13
$L_W$	20 - 32	+8	+5	+3	-1	-4	-7	-9	-12

Extra performance only from plate mounted fans.

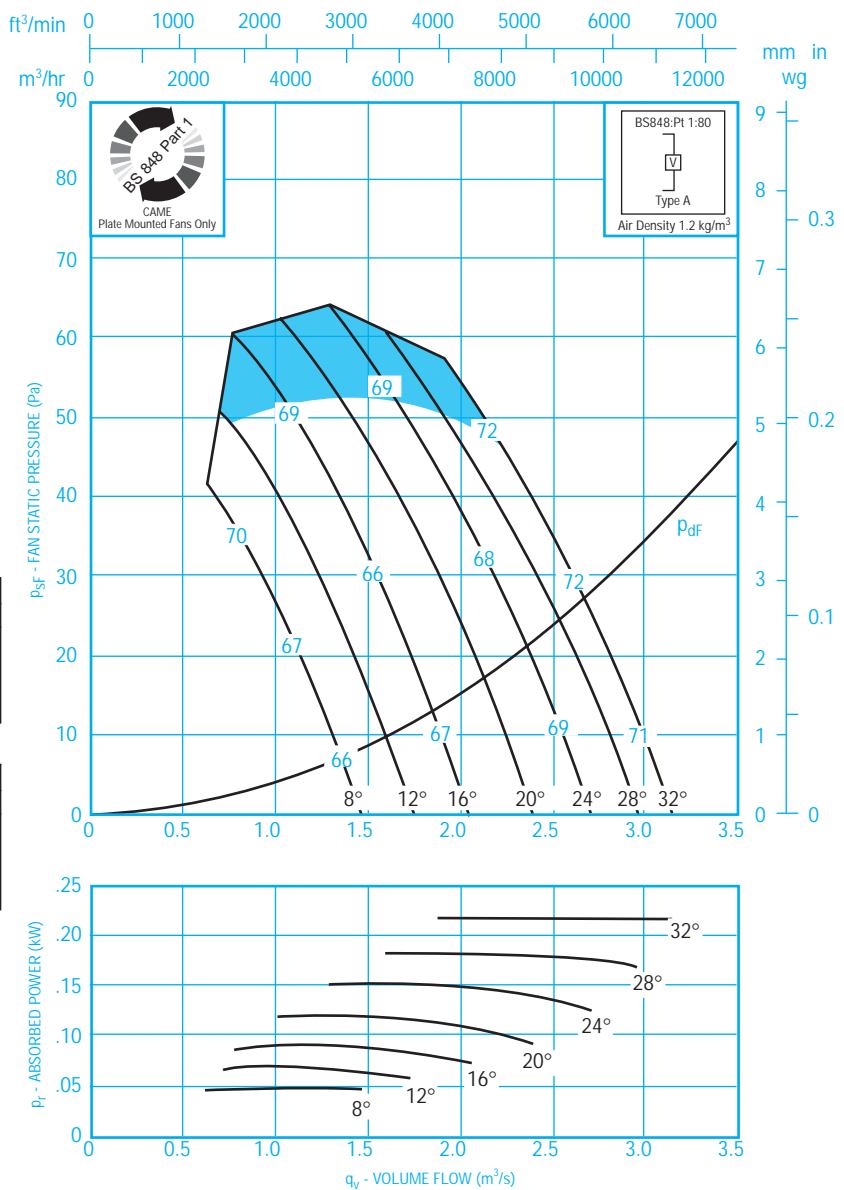

### Electrical Data

220-240 V / 50 Hz / 1  $\phi$

Chart No. 19

Motor	Fixed Speed				Speed Controllable					
	Pitch Angle (°)	Motor Rating (kW)	Full Load (A)	Starting Current (A)	Pitch Angle (°)	Motor Rating (kW)	Full Load (A)	Starting Current (A)	Speed Controller	
									Electronic	Auto-Transformer
CT5	20 - 24	0.16	1.5	2.5	16 - 20	0.13	1.3	2.1	ME1.3	MT1.5
CT9	30 - 32	0.3	2.7	3.5	30 - 32	0.25	2.3	3.4	ME1.6	MT1.5
-	-	-	-	-	-	-	-	-	-	-

380-420 V / 50 Hz / 3  $\phi$

Motor	Fixed Speed				Speed Controllable					
	Pitch Angle (°)	Motor Rating (kW)	Full Load (A)	Starting Current (A)	Pitch Angle (°)	Motor Rating (kW)	Full Load (A)	Starting Current (A)	Speed Control	
									Electronic	$\Delta/\Lambda$ * Pitch Angle
CT5	8 - 24	0.16	0.8	1.5	16 - 20	0.13	0.7	1.5	ME3.2D	20
CT9	26 - 32	0.3	1.4	2.6	28 - 32	0.25	1.2	2.6	ME3.2D	34
-	-	-	-	-	-	-	-	-	-	-

\* By connecting these 3 phase motors in star ( $\Lambda$ ), a second speed will be obtained approximately 80% of the full speed at the angle shown. (A Woods two speed switch type MDS3.10 is available). For dimensions and weights of this fan please refer to pages 54 and 55.

# AEROFOIL CLIMAFAN



## Fan Code: 71AC/8/6/...

## 710 mm 680 rev/min 6 Blades 50 Hz

### Performance Data

#### BS 848 Pt 1 1980

Performance shown is specifically for non-ducted installations.

### Sound Data

#### BS 848 Pt 2 1985

Single figures on performance curves are overall inlet sound power levels, "A" weighted ( $L_{WA}$  re: 1 pW), derived from measurements taken in Woods laboratory specifically under non-ducted free field conditions. For sound power levels in eight octave bands, apply the following corrections to the overall level:

#### Inlet Levels

	Pitch Angle	Frequency Hz							
		63	125	250	500	1K	2K	4K	8K
$L_{WA}$	8 - 18	-30	-17	-9	-4	-5	-9	-16	-24
$L_W$	8 - 18	-4	-1	0	-1	-5	-10	-17	-23
$L_{WA}$	20 - 36	-26	-16	-9	-5	-5	-8	-12	-16
$L_W$	20 - 36	0	0	0	-2	-5	-9	-13	-15

#### Outlet Levels

	Pitch Angle	Frequency Hz							
		63	125	250	500	1K	2K	4K	8K
$L_{WA}$	8 - 18	-22	-11	-4	-2	-3	-7	-13	-20
$L_W$	8 - 18	+4	+5	+5	+1	-3	-8	-14	-19
$L_{WA}$	20 - 36	-18	-9	-5	-3	-3	-6	-9	-13
$L_W$	20 - 36	+8	+7	+4	0	-3	-7	-10	-12

Extra performance only from plate mounted fans.

Three blade performance available. See chart number 19

### Electrical Data

220-240 V / 50 Hz / 1  $\phi$

Chart No. 20

Motor	Fixed Speed				Speed Controllable					
	Pitch Angle (°)	Motor Rating (kW)	Full Load (A)	Starting Current (A)	Pitch Angle (°)	Motor Rating (kW)	Full Load (A)	Starting Current (A)	Speed Controller	
									Electronic	Auto-Transformer
CT5	10 - 14	0.16	1.5	2.5	8 - 10	0.13	1.3	2.1	ME1.3	MT1.5
CT9	18 - 24	0.3	2.7	3.5	18 - 22	0.25	2.3	3.4	ME1.6	MT1.5
F2265	-	-	-	-	34 - 36	0.65	4.9	12	ME1.6	MT1.8

380-420 V / 50 Hz / 3  $\phi$

Motor	Fixed Speed				Speed Controllable					
	Pitch Angle (°)	Motor Rating (kW)	Full Load (A)	Starting Current (A)	Pitch Angle (°)	Motor Rating (kW)	Full Load (A)	Starting Current (A)	Speed Control	
									Electronic	$\Delta/\lambda$ * Pitch Angle
CT5	8 - 12	0.16	0.8	1.5	8 - 10	0.13	0.7	1.5	ME3.2D	10
CT9	14 - 24	0.3	1.4	2.6	18 - 22	0.25	1.2	2.6	ME3.2D	22
F2265	26 - 36	0.8	2.8	8	34 - 36	0.65	2.4	8	ME3.2D	-

\* By connecting these 3 phase motors in star ( $\lambda$ ), a second speed will be obtained approximately 80% of the full speed at the angle shown. (A Woods two speed switch type MDS3.10 is available). For dimensions and weights of this fan please refer to pages 54 and 55.

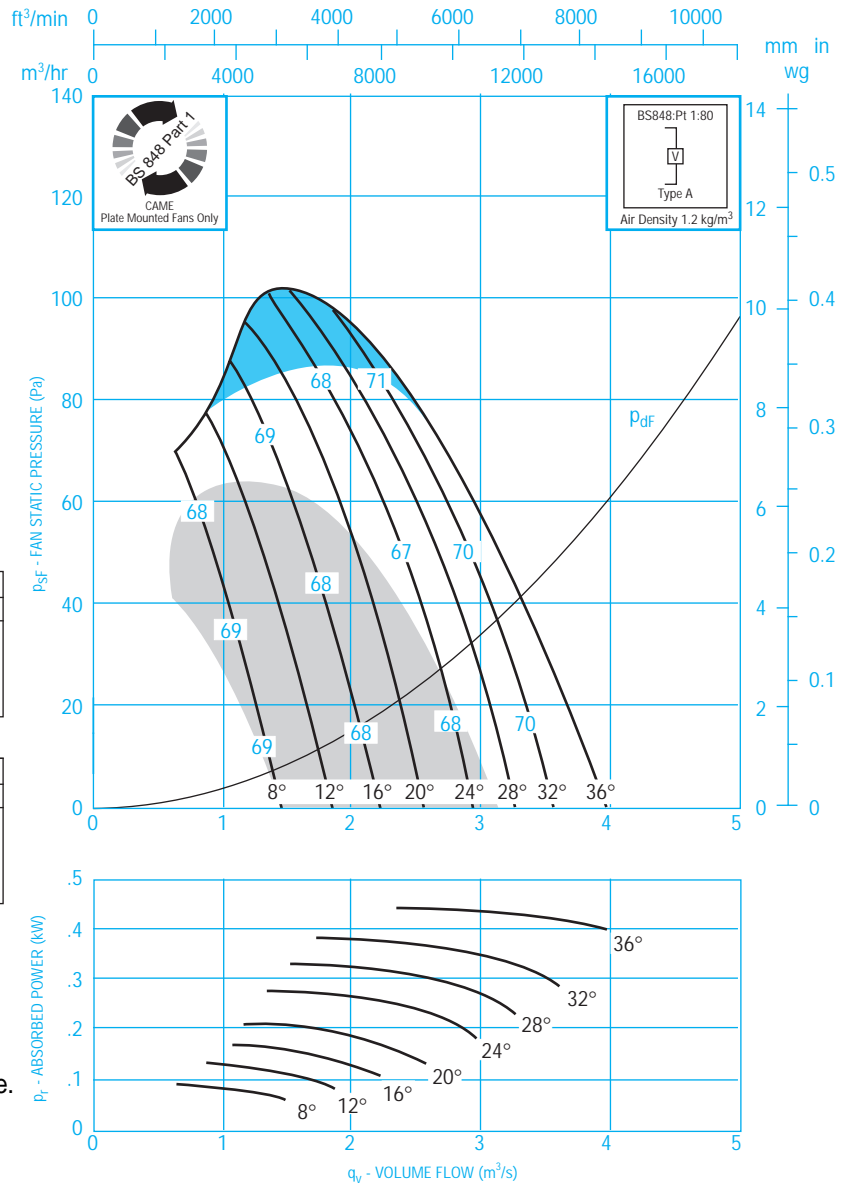

# AEROFOIL CLIMAFAN



## Fan Code: 71AC/6/3/...

## 710 mm 900 rev/min 3 Blades 50 Hz



### Performance Data

#### BS 848 Pt 1 1980

Performance shown is specifically for non-ducted installations.

### Sound Data

#### BS 848 Pt 2 1985

Single figures on performance curves are overall inlet sound power levels, "A" weighted ( $L_{WA}$  re: 1 pW), derived from measurements taken in Woods laboratory specifically under non-ducted free field conditions. For sound power levels in eight octave bands, apply the following corrections to the overall level:

#### Inlet Levels

	Pitch Angle	Frequency Hz							
		63	125	250	500	1K	2K	4K	8K
$L_{WA}$	8 - 18	-27	-16	-8	-5	-6	-9	-13	-21
$L_W$	8 - 18	-1	0	+1	-2	-6	-10	-14	-20
$L_{WA}$	20 - 32	-25	-15	-8	-6	-6	-8	-11	-16
$L_W$	20 - 32	+1	+1	+1	-3	-6	-9	-12	-15

#### Outlet Levels

	Pitch Angle	Frequency Hz							
		63	125	250	500	1K	2K	4K	8K
$L_{WA}$	8 - 18	-21	-12	-5	-3	-4	-7	-11	-18
$L_W$	8 - 18	+5	+4	+4	0	-4	-8	-12	-17
$L_{WA}$	20 - 32	-18	-11	-6	-4	-4	-6	-8	-13
$L_W$	20 - 32	+8	+5	+3	-1	-4	-7	-9	-12

Extra performance only from plate mounted fans.

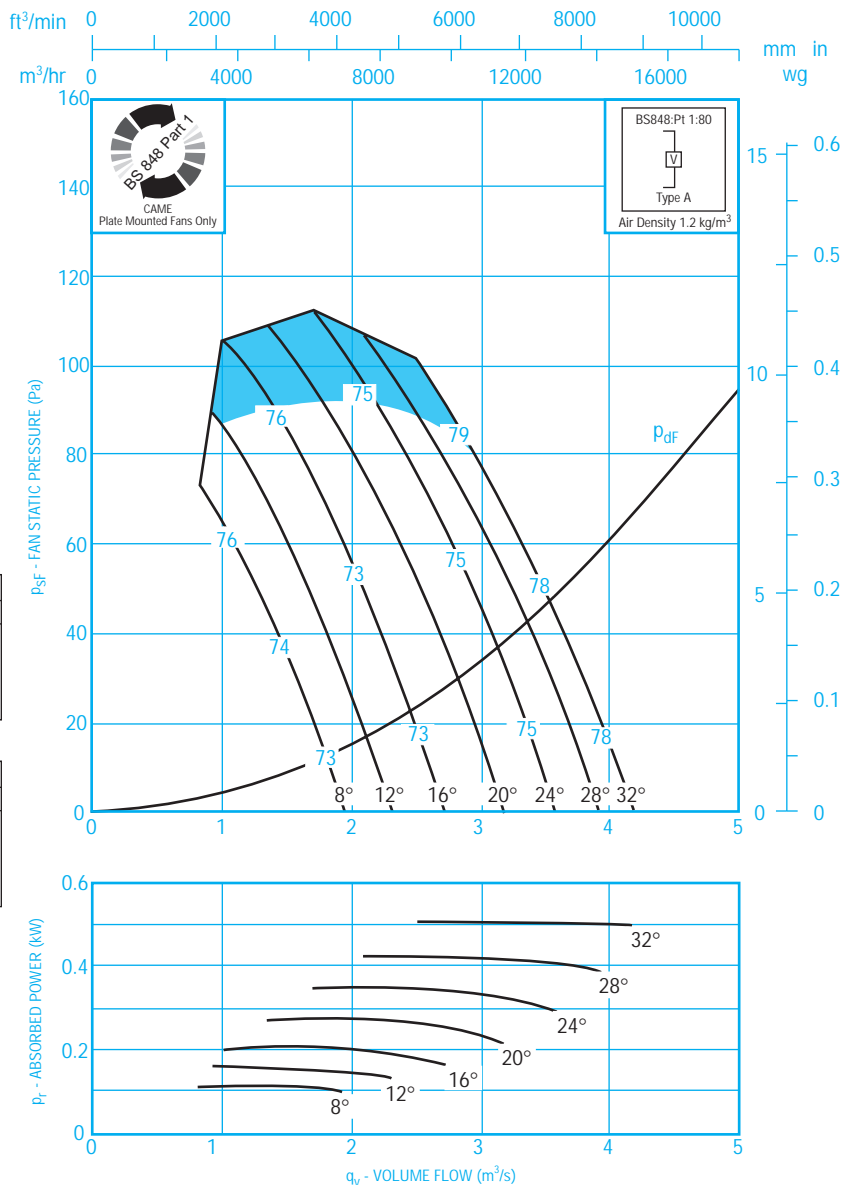

### Electrical Data

220-240 V / 50 Hz / 1  $\phi$

Chart No. 21

Motor	Fixed Speed				Speed Controllable					
	Pitch Angle (°)	Motor Rating (kW)	Full Load (A)	Starting Current (A)	Pitch Angle (°)	Motor Rating (kW)	Full Load (A)	Starting Current (A)	Speed Controller	
									Electronic	Auto-Transformer
CT5	18 - 24	0.37	2.9	4	20	0.3	2.4	4	ME1.3	MT1.5
CT9	32	0.68	5.2	6.5	32	0.52	4	9.2	ME1.6	MT1.8
-	-	-	-	-	-	-	-	-	-	-

380-420 V / 50 Hz / 3  $\phi$

Motor	Fixed Speed				Speed Controllable					
	Pitch Angle (°)	Motor Rating (kW)	Full Load (A)	Starting Current (A)	Pitch Angle (°)	Motor Rating (kW)	Full Load (A)	Starting Current (A)	Speed Control	
									Electronic	$\Delta/\Lambda$ * Pitch Angle
CT5	8 - 24	0.37	1.3	3.3	18 - 20	0.3	1.1	3.3	ME3.2D	20
CT9	26 - 32	0.68	2.2	7.5	28 - 32	0.52	1.7	7.5	ME3.2D	32
-	-	-	-	-	-	-	-	-	-	-

\* By connecting these 3 phase motors in star ( $\Lambda$ ), a second speed will be obtained approximately 80% of the full speed at the angle shown. (A Woods two speed switch type MDS3.10 is available). For dimensions and weights of this fan please refer to pages 54 and 55.

# AEROFOIL CLIMAFAN



## Fan Code: 71AC/6/6/...

## 710 mm 900 rev/min 6 Blades 50 Hz

### Performance Data

#### BS 848 Pt 1 1980

Performance shown is specifically for non-ducted installations.

### Sound Data

#### BS 848 Pt 2 1985

Single figures on performance curves, "A" weighted ( $L_{WA}$  re: 1 pW), derived from measurements taken in Woods laboratory specifically under non-ducted free field conditions. For sound power levels in eight octave bands, apply the following corrections to the overall level:

#### Inlet Levels

	Pitch Angle	Frequency Hz							
		63	125	250	500	1K	2K	4K	8K
$L_{WA}$	8 - 18	-35	-21	-12	-5	-4	-8	-13	-22
$L_W$	8 - 18	-9	-5	-3	-2	-4	-9	-14	-21
$L_{WA}$	20 - 36	-29	-18	-10	-6	-5	-7	-12	-17
$L_W$	20 - 36	-3	-2	-1	-3	-5	-8	-13	-16

#### Outlet Levels

	Pitch Angle	Frequency Hz							
		63	125	250	500	1K	2K	4K	8K
$L_{WA}$	8 - 18	-31	-14	-5	-1	-2	-6	-11	-19
$L_W$	8 - 18	-5	+2	+4	+2	-2	-7	-12	-18
$L_{WA}$	20 - 36	-25	-10	-4	-2	-3	-6	-9	-14
$L_W$	20 - 36	+1	+6	+5	+1	-3	-7	-10	-13

Extra performance only from plate mounted fans.

Three blade performance available. See chart number 21

### Electrical Data

220-240 V / 50 Hz / 1  $\phi$

Chart No. 22

Motor	Fixed Speed				Speed Controllable					
	Pitch Angle (°)	Motor Rating (kW)	Full Load (A)	Starting Current (A)	Pitch Angle (°)	Motor Rating (kW)	Full Load (A)	Starting Current (A)	Speed Controller	
									Electronic	Auto-Transformer
CT5	10 - 14	0.37	2.9	4	10	0.3	2.4	4	ME1.3	MT1.5
CT9	20 - 24	0.68	5.2	6.5	20	0.52	4	9.2	ME1.6	MT1.8
F2265	34 - 36	1.55	9.8	27	36	1.35	8.7	27	ME1.10	-

380-420 V / 50 Hz / 3  $\phi$

Motor	Fixed Speed				Speed Controllable					
	Pitch Angle (°)	Motor Rating (kW)	Full Load (A)	Starting Current (A)	Pitch Angle (°)	Motor Rating (kW)	Full Load (A)	Starting Current (A)	Speed Control	
									Electronic	$\Delta/\Delta$ * Pitch Angle
CT5	8 - 12	0.37	1.3	3.3	10	0.3	1.1	3.3	ME3.2D	10
CT9	14 - 24	0.68	2.2	7.5	16 - 20	0.52	1.7	7.5	ME3.2D	20
F2265	26 - 36	1.55	4	15	36	1.35	3.6	15	-	-

\* By connecting these 3 phase motors in star ( $\Delta$ ), a second speed will be obtained approximately 80% of the full speed at the angle shown. (A Woods two speed switch type MDS3.10 is available). For dimensions and weights of this fan please refer to pages 54 and 55.

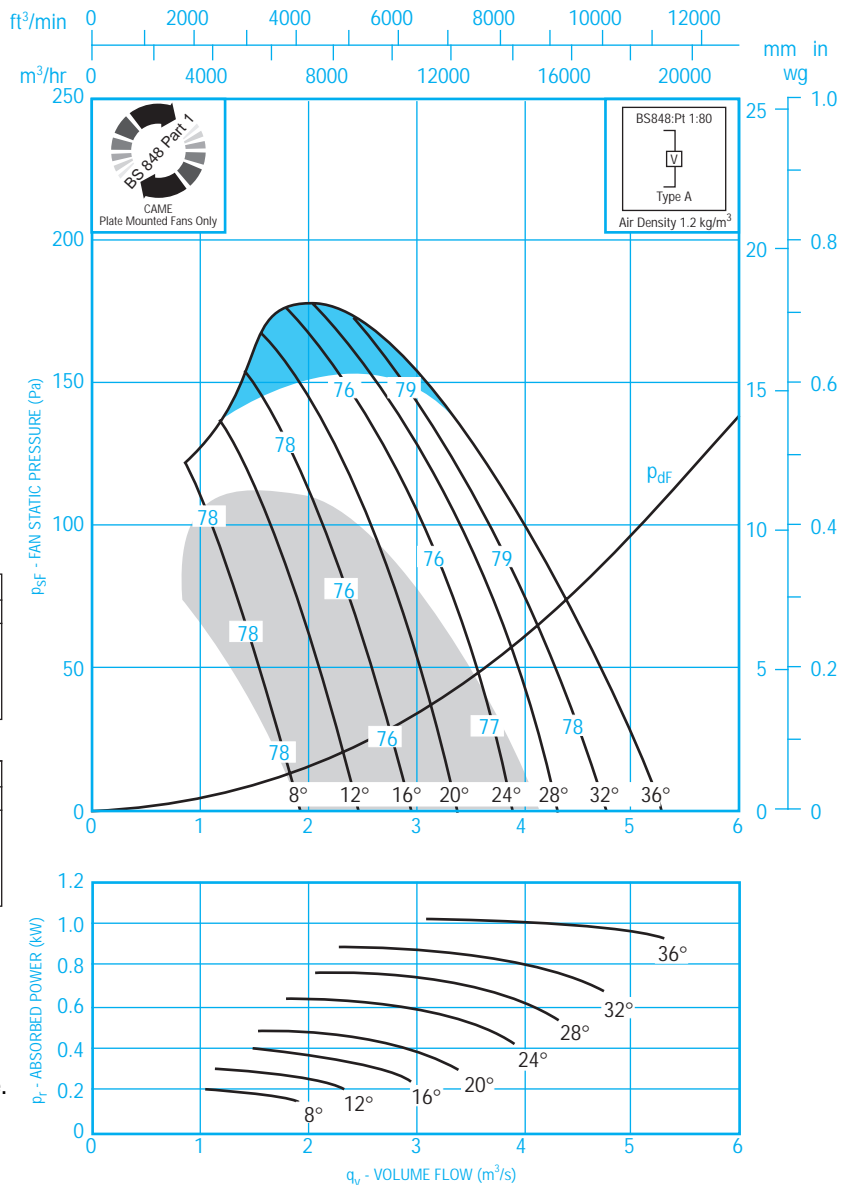

# AEROFOIL CLIMAFAN



BS 5750 Pt 1  
EN 29001  
ISO 9001

## Fan Code: 71AC/4/3/...

## 710 mm 1420 rev/min 3 Blades 50 Hz



### Performance Data

#### BS 848 Pt 1 1980

Performance shown is specifically for non-ducted installations.

### Sound Data

#### BS 848 Pt 2 1985

Single figures on performance curves are overall inlet sound power levels, "A" weighted ( $L_{WA}$  re: 1 pW), derived from measurements taken in Woods laboratory specifically under non-ducted free field conditions. For sound power levels in eight octave bands, apply the following corrections to the overall level:

#### Inlet Levels

	Pitch Angle	Frequency Hz							
		63	125	250	500	1K	2K	4K	8K
$L_{WA}$	8 - 18	-30	-21	-11	-4	-5	-8	-12	-19
$L_W$	8 - 18	-4	-5	-2	-1	-5	-9	-13	-18
$L_{WA}$	20 - 32	-27	-18	-10	-5	-6	-8	-10	-16
$L_W$	20 - 32	-1	-2	-1	-2	-6	-9	-11	-15

#### Outlet Levels

	Pitch Angle	Frequency Hz							
		63	125	250	500	1K	2K	4K	8K
$L_{WA}$	8 - 18	-24	-18	-7	-2	-3	-6	-10	-17
$L_W$	8 - 18	+2	-2	+2	+1	-3	-7	-11	-16
$L_{WA}$	20 - 32	-21	-15	-7	-3	-4	-6	-8	-13
$L_W$	20 - 32	+5	+1	+2	0	-4	-7	-9	-12

Extra performance only from plate mounted fans.

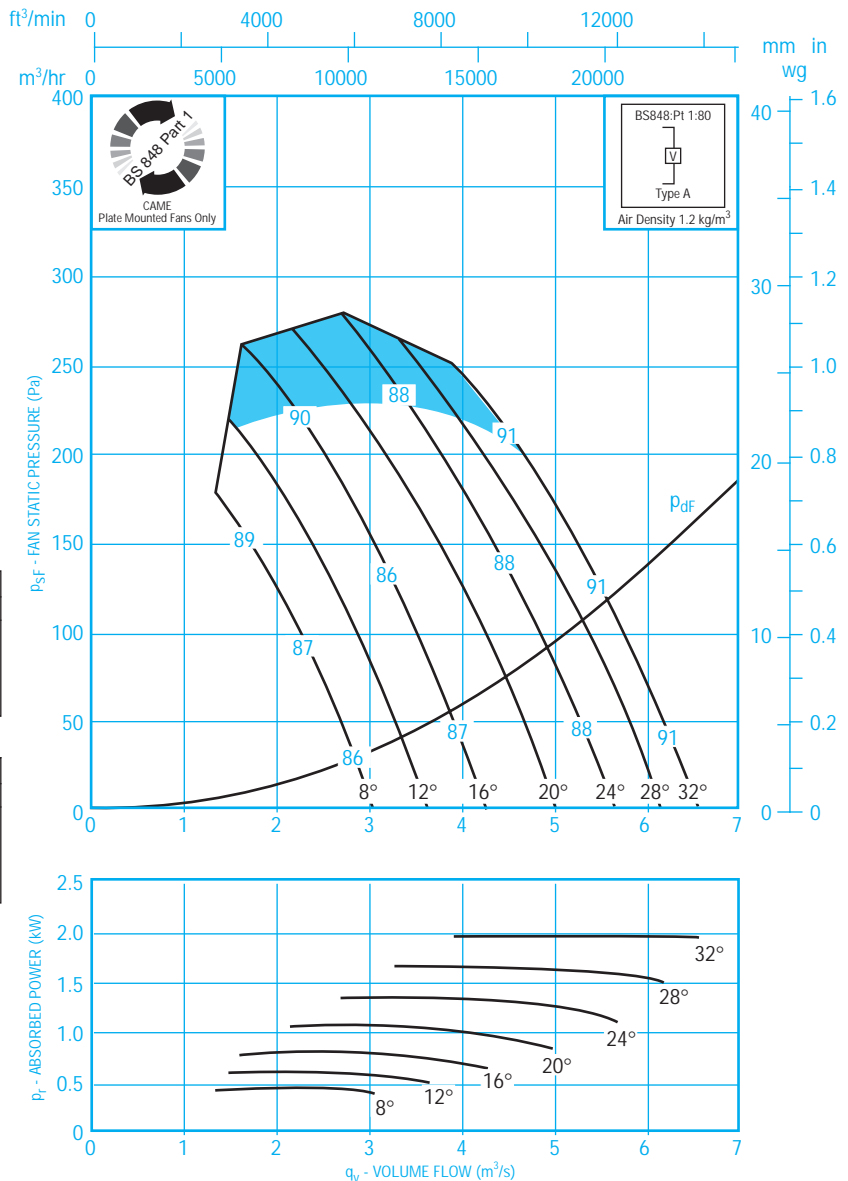

### Electrical Data

220-240 V / 50 Hz / 1  $\phi$

Chart No. 23

Motor	Fixed Speed				Speed Controllable					
	Pitch Angle (°)	Motor Rating (kW)	Full Load (A)	Starting Current (A)	Pitch Angle (°)	Motor Rating (kW)	Full Load (A)	Starting Current (A)	Speed Controller	
									Electronic	Auto-Transformer
CT5	8 - 12	0.7	4.4	9.5	-	-	-	-	-	-
CT9	18 - 22	1.3	8.2	23	20	1.1	7.2	23	ME1.10	-
F2245	26 - 30	2	11	35	26 - 28	1.7	10	33	-	-

380-420 V / 50 Hz / 3  $\phi$

Motor	Fixed Speed				Speed Controllable					
	Pitch Angle (°)	Motor Rating (kW)	Full Load (A)	Starting Current (A)	Pitch Angle (°)	Motor Rating (kW)	Full Load (A)	Starting Current (A)	Speed Control	
									Electronic	$\Delta/\Lambda$ * Pitch Angle
CT5	8 - 12	0.71	1.9	6.5	8 - 10	0.58	1.7	6.5	ME3.2D	10
CT9	14 - 24	1.4	3.5	14	18 - 20	1.15	3	11.4	ME3.2D	20
F2265	26 - 36	2.7	5.8	30	28 - 32	2.1	4.7	30	-	32

\* By connecting these 3 phase motors in star ( $\Lambda$ ), a second speed will be obtained approximately 80% of the full speed at the angle shown. (A Woods two speed switch type MDS3.10 is available). For dimensions and weights of this fan please refer to pages 54 and 55.

# AEROFOIL CLIMAFAN



## Fan Code: 71AC/4/6/...

## 710 mm 1440 rev/min 6 Blades 50 Hz

### Performance Data

#### BS 848 Pt 1 1980

Performance shown is specifically for non-ducted installations.

### Sound Data

#### BS 848 Pt 2 1985

Single figures on performance curves are overall inlet sound power levels, "A" weighted ( $L_{WA}$  re: 1 pW), derived from measurements taken in Woods laboratory specifically under non-ducted free field conditions. For sound power levels in eight octave bands, apply the following corrections to the overall level:

#### Inlet Levels

	Pitch Angle	Frequency Hz							
		63	125	250	500	1K	2K	4K	8K
$L_{WA}$	8 - 18	-38	-24	-16	-6	-4	-6	-11	-19
$L_W$	8 - 18	-12	-8	-7	-3	-4	-7	-12	-18
$L_{WA}$	20 - 36	-34	-19	-13	-7	-5	-6	-10	-16
$L_W$	20 - 36	-8	-3	-4	-4	-5	-7	-11	-15

#### Outlet Levels

	Pitch Angle	Frequency Hz							
		63	125	250	500	1K	2K	4K	8K
$L_{WA}$	8 - 18	-34	-16	-9	-2	-1	-4	-9	-17
$L_W$	8 - 18	-8	0	0	+1	-1	-5	-10	-16
$L_{WA}$	20 - 36	-30	-11	-6	-2	-2	-4	-8	-13
$L_W$	20 - 36	-4	+5	+3	+1	-2	-5	-9	-12

Extra performance only from plate mounted fans.

Three blade performance available. See chart number 23.

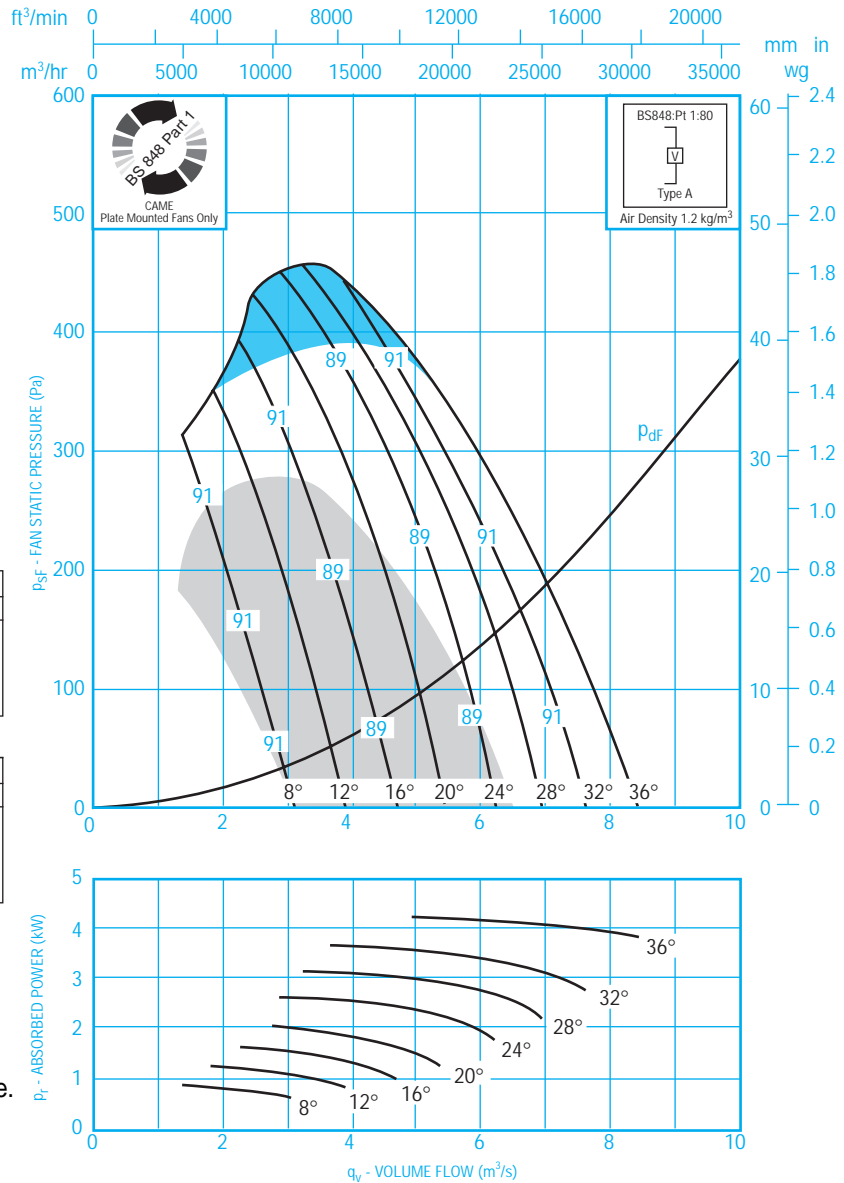

### Electrical Data

220-240 V / 50 Hz / 1  $\phi$

Chart No. 24

Motor	Fixed Speed				Speed Controllable						
	Pitch Angle (°)	Motor Rating (kW)	Full Load (A)	Starting Current (A)	Pitch Angle (°)	Motor Rating (kW)	Full Load (A)	Starting Current (A)	Speed Controller		
									Electronic	Auto-Transformer	
CT9	10 - 12	1.3	8.2	23	10	1.1	7.2	23	ME1.10	-	
F2245	16 - 18	2	11	35	14 - 16	1.7	10	33	-	-	
F2249	22 - 28	3.2	18	62	-	-	-	-	-	-	

380-420 V / 50 Hz / 3  $\phi$

Motor	Fixed Speed				Speed Controllable						
	Pitch Angle (°)	Motor Rating (kW)	Full Load (A)	Starting Current (A)	Pitch Angle (°)	Motor Rating (kW)	Full Load (A)	Starting Current (A)	Speed Control		
									Electronic	$\Delta/\lambda$ * Pitch Angle	
CT9	8 - 12	1.4	3.5	14	10	1.15	3	11.4	ME3.2D	10	
F2245	14 - 24	2.7	5.8	30	16 - 18	2.1	4.7	30	-	18	
F2249	26 - 36	4.4	9.3	52	-	-	-	-	-	-	

\* By connecting these 3 phase motors in star ( $\lambda$ ), a second speed will be obtained approximately 80% of the full speed at the angle shown. (A Woods two speed switch type MDS3.10 is available). For dimensions and weights of this fan please refer to pages 54 and 55.



# AEROFOIL CLIMAFAN



## Fan Code: 80AC/8/3/...

## 800 mm 680 rev/min 3 Blades 50 Hz



### Performance Data

#### BS 848 Pt 1 1980

Performance shown is specifically for non-ducted installations.

### Sound Data

#### BS 848 Pt 2 1985

Single figures on performance curves are overall inlet sound power levels, "A" weighted ( $L_{WA}$  re: 1 pW), derived from measurements taken in Woods laboratory specifically under non-ducted free field conditions. For sound power levels in eight octave bands, apply the following corrections to the overall level:

#### Inlet Levels

	Pitch Angle	Frequency Hz							
		63	125	250	500	1K	2K	4K	8K
$L_{WA}$	8 - 18	-29	-16	-8	-6	-6	-8	-12	-20
$L_W$	8 - 18	-3	0	+1	-3	-6	-9	-13	-19
$L_{WA}$	20 - 32	-24	-15	-9	-7	-6	-7	-9	-14
$L_W$	20 - 32	+2	+1	0	-4	-6	-8	-10	-13

#### Outlet Levels

	Pitch Angle	Frequency Hz							
		63	125	250	500	1K	2K	4K	8K
$L_{WA}$	8 - 18	-23	-12	-6	-4	-4	-6	-10	-17
$L_W$	8 - 18	+3	+4	+3	-1	-4	-7	-11	-16
$L_{WA}$	20 - 32	-19	-11	-6	-5	-4	-5	-6	-11
$L_W$	20 - 32	+7	+5	+3	-2	-4	-6	-7	-10

Extra performance only from plate mounted fans.

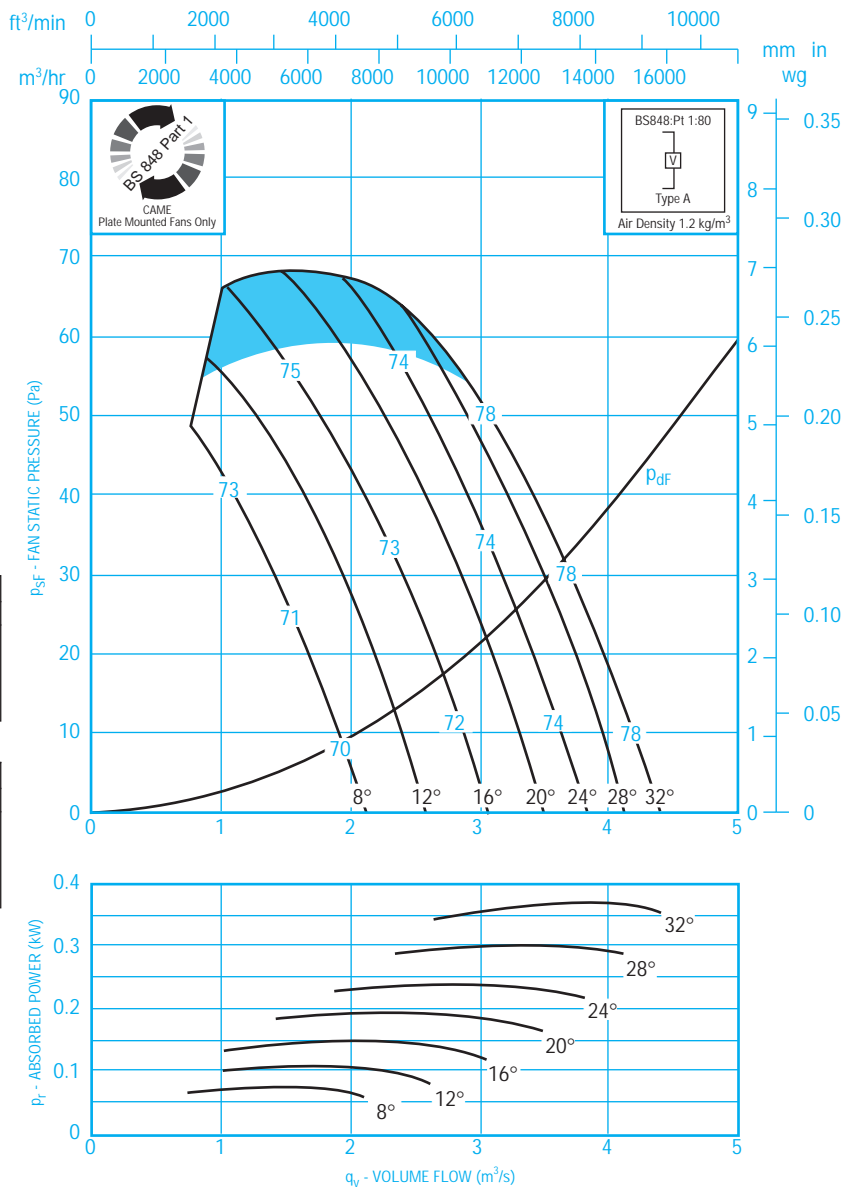

### Electrical Data

220-240 V / 50 Hz / 1  $\phi$

Chart No. 25

Motor	Fixed Speed				Speed Controllable					
	Pitch Angle (°)	Motor Rating (kW)	Full Load (A)	Starting Current (A)	Pitch Angle (°)	Motor Rating (kW)	Full Load (A)	Starting Current (A)	Speed Controller	
									Electronic	Auto-Transformer
CT9	20 - 24	0.3	2.7	3.5	20 - 22	0.25	2.3	3.4	ME1.6	MT1.5
F2265	-	-	-	-	32	0.65	4.9	12	ME1.6	MT1.8
-	-	-	-	-	-	-	-	-	-	-

380-420 V / 50 Hz / 3  $\phi$

Motor	Fixed Speed				Speed Controllable					
	Pitch Angle (°)	Motor Rating (kW)	Full Load (A)	Starting Current (A)	Pitch Angle (°)	Motor Rating (kW)	Full Load (A)	Starting Current (A)	Speed Control	
									Electronic	$\Delta/\lambda$ * Pitch Angle
CT9	8 - 24	0.3	1.4	2.6	18 - 22	0.25	1.2	2.6	ME3.2D	22
F2265	26 - 32	0.8	2.8	8	32	0.65	2.4	8	ME3.2D	-
-	-	-	-	-	-	-	-	-	-	-

\* By connecting these 3 phase motors in star ( $\lambda$ ), a second speed will be obtained approximately 80% of the full speed at the angle shown. (A Woods two speed switch type MDS3.10 is available). For dimensions and weights of this fan please refer to pages 54 and 55.

# AEROFOIL CLIMAFAN



## Fan Code: 80AC/8/6/...

## 800 mm 695 rev/min 6 Blades 50 Hz

### Performance Data

#### BS 848 Pt 1 1980

Performance shown is specifically for non-ducted installations.

### Sound Data

#### BS 848 Pt 2 1985

Single figures on performance curves are overall inlet sound power levels, "A" weighted ( $L_{WA}$  re: 1 pW), derived from measurements taken in Woods laboratory specifically under non-ducted free field conditions. For sound power levels in eight octave bands, apply the following corrections to the overall level:

#### Inlet Levels

	Pitch Angle	Frequency Hz							
		63	125	250	500	1K	2K	4K	8K
$L_{WA}$	8 - 18	-32	-18	-9	-4	-5	-9	-15	-24
$L_W$	8 - 18	-6	-2	0	-1	-5	-10	-16	-23
$L_{WA}$	20 - 36	-27	-17	-10	-6	-5	-7	-10	-16
$L_W$	20 - 36	-1	-1	-1	-3	-5	-8	-11	-15

#### Outlet Levels

	Pitch Angle	Frequency Hz							
		63	125	250	500	1K	2K	4K	8K
$L_{WA}$	8 - 18	-24	-11	-5	-2	-3	-8	-13	-21
$L_W$	8 - 18	+2	+5	+4	+1	-3	-9	-14	-20
$L_{WA}$	20 - 36	-19	-9	-5	-4	-4	-5	-8	-13
$L_W$	20 - 36	+7	+7	+4	-1	-4	-6	-9	-12

Extra performance only from plate mounted fans.

Three blade performance available. See chart number 25.

### Electrical Data

220-240 V / 50 Hz / 1  $\phi$

Chart No. 26

Motor	Fixed Speed				Speed Controllable					
	Pitch Angle (°)	Motor Rating (kW)	Full Load (A)	Starting Current (A)	Pitch Angle (°)	Motor Rating (kW)	Full Load (A)	Starting Current (A)	Speed Controller	
									Electronic	Auto-Transformer
CT9	12 - 16	0.3	2.7	3.5	12	0.25	2.3	3.4	ME1.6	MT1.5
F2265	28 - 34	0.8	5.9	12	22 - 30	0.65	4.9	12	ME1.6	MT1.8
-	-	-	-	-	-	-	-	-	-	-

380-420 V / 50 Hz / 3  $\phi$

Motor	Fixed Speed				Speed Controllable					
	Pitch Angle (°)	Motor Rating (kW)	Full Load (A)	Starting Current (A)	Pitch Angle (°)	Motor Rating (kW)	Full Load (A)	Starting Current (A)	Speed Control	
									Electronic	$\Delta/\lambda$ * Pitch Angle
CT9	8 - 14	0.3	1.4	2.6	10 - 12	0.25	1.2	2.6	ME3.2D	12
F2265	16 - 34	0.8	2.8	8	22 - 30	0.65	2.4	8	ME3.2D	30
F2269	36	1.4	4.7	14	-	-	-	-	-	-

\* By connecting these 3 phase motors in star ( $\lambda$ ), a second speed will be obtained approximately 80% of the full speed at the angle shown. (A Woods two speed switch type MDS3.10 is available). For dimensions and weights of this fan please refer to pages 54 and 55.

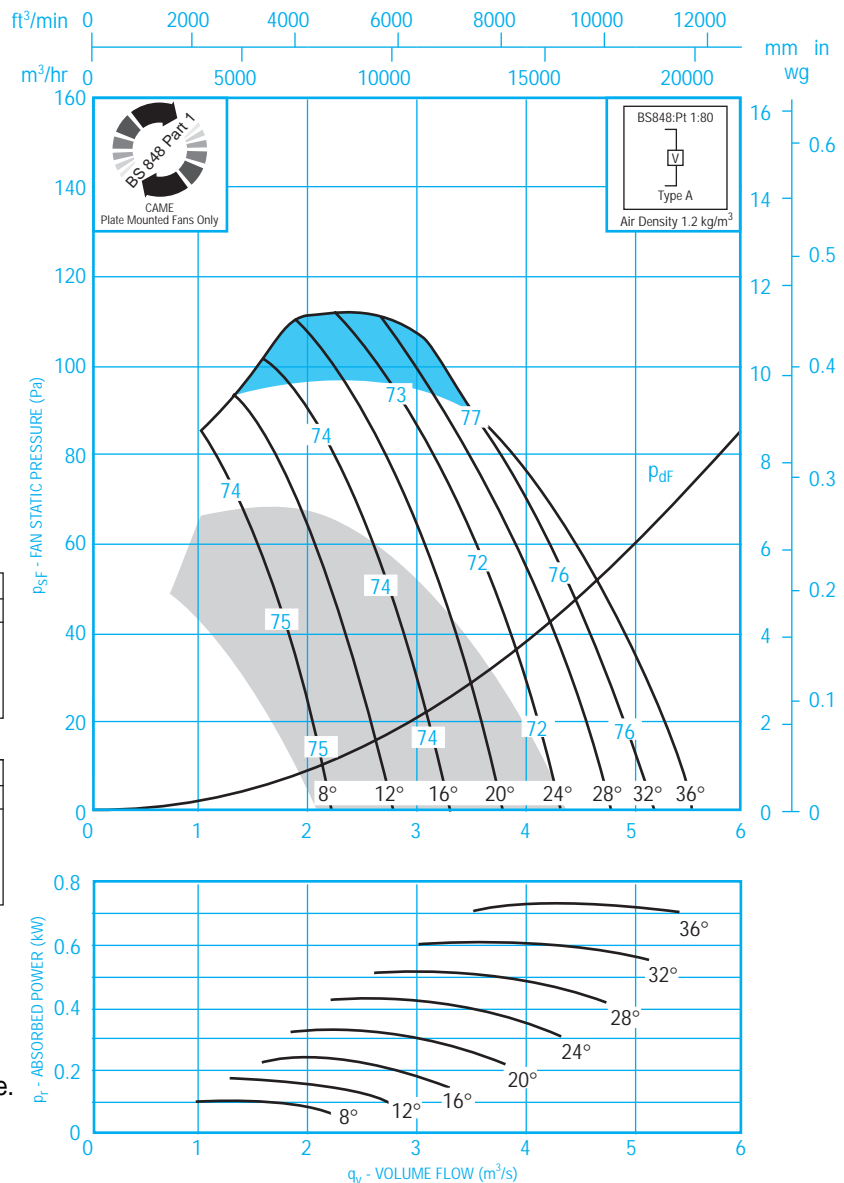

# AEROFOIL CLIMAFAN



## Fan Code: 80AC/6/3/...

## 800 mm 900 rev/min 3 Blades 50 Hz



### Performance Data

#### BS 848 Pt 1 1980

Performance shown is specifically for non-ducted installations.

### Sound Data

#### BS 848 Pt 2 1985

Single figures on performance curves are overall inlet sound power levels, "A" weighted ( $L_{WA}$  re: 1 pW), derived from measurements taken in Woods laboratory specifically under non-ducted free field conditions. For sound power levels in eight octave bands, apply the following corrections to the overall level:

#### Inlet Levels

	Pitch Angle	Frequency Hz							
		63	125	250	500	1K	2K	4K	8K
$L_{WA}$	8 - 18	-29	-16	-8	-6	-5	-8	-12	-20
$L_W$	8 - 18	-3	0	+1	-3	-5	-9	-13	-19
$L_{WA}$	20 - 32	-24	-15	-9	-7	-6	-7	-9	-15
$L_W$	20 - 32	+2	+1	0	-4	-6	-8	-10	-14

#### Outlet Levels

	Pitch Angle	Frequency Hz							
		63	125	250	500	1K	2K	4K	8K
$L_{WA}$	8 - 18	-22	-12	-5	-4	-3	-6	-10	-17
$L_W$	8 - 18	+4	+4	+4	-1	-3	-7	-11	-16
$L_{WA}$	20 - 32	-19	-11	-6	-5	-4	-5	-6	-12
$L_W$	20 - 32	+7	+5	+3	-2	-4	-6	-7	-11

Extra performance only from plate mounted fans.

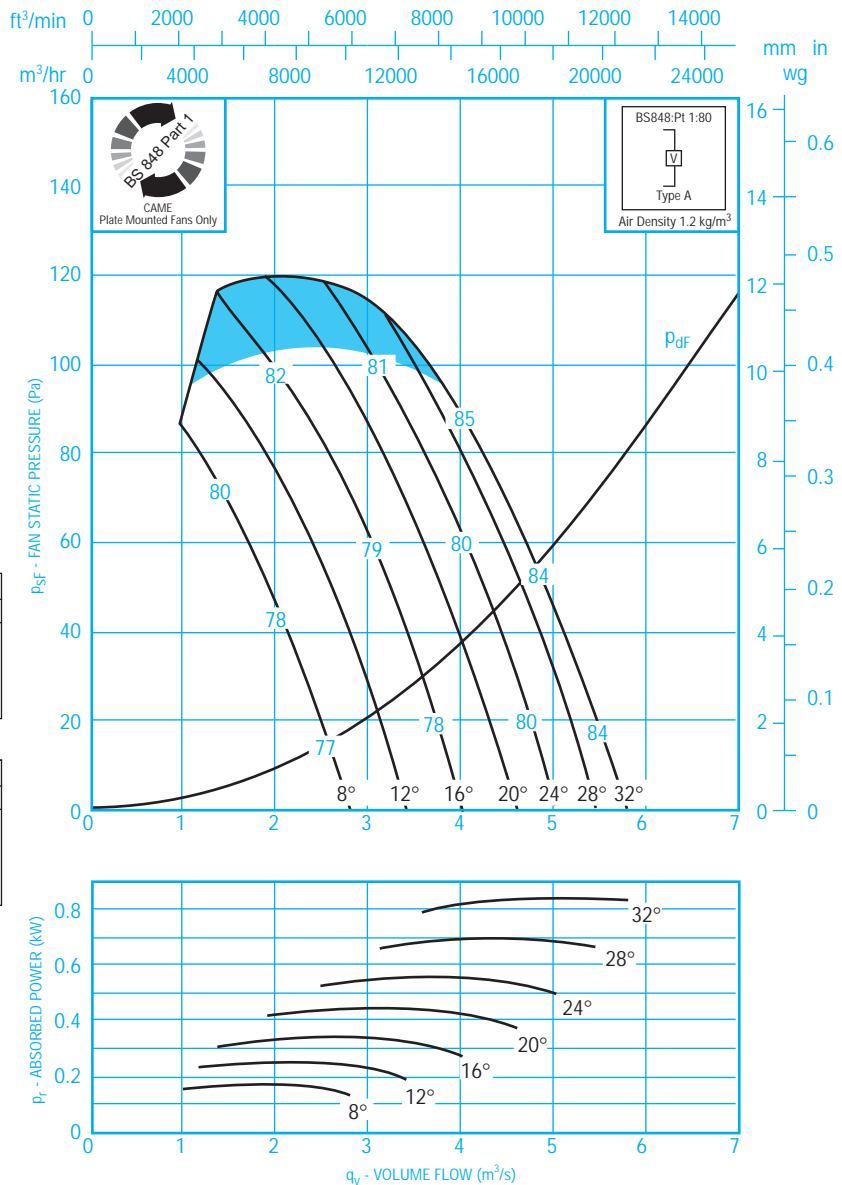

### Electrical Data

220-240 V / 50 Hz / 1  $\phi$

Chart No. 27

Motor	Fixed Speed				Speed Controllable					
	Pitch Angle (°)	Motor Rating (kW)	Full Load (A)	Starting Current (A)	Pitch Angle (°)	Motor Rating (kW)	Full Load (A)	Starting Current (A)	Speed Controller	
									Electronic	Auto-Transformer
CT9	20 - 24	0.68	5.2	6.5	20	0.52	4	9.2	ME1.6	MT1.8
F2265	32	1.55	9.8	27	-	-	-	-	-	-
-	-	-	-	-	-	-	-	-	-	-

380-420 V / 50 Hz / 3  $\phi$

Motor	Fixed Speed				Speed Controllable					
	Pitch Angle (°)	Motor Rating (kW)	Full Load (A)	Starting Current (A)	Pitch Angle (°)	Motor Rating (kW)	Full Load (A)	Starting Current (A)	Speed Control	
									Electronic	$\Delta/\lambda$ * Pitch Angle
CT9	8 - 24	0.68	2.2	7.5	18 - 20	0.52	1.7	7.5	ME3.2D	20
F2265	26 - 32	1.55	4	15	-	-	-	-	-	-
-	-	-	-	-	-	-	-	-	-	-

\* By connecting these 3 phase motors in star ( $\lambda$ ), a second speed will be obtained approximately 80% of the full speed at the angle shown. (A Woods two speed switch type MDS3.10 is available). For dimensions and weights of this fan please refer to pages 54 and 55.

# AEROFOIL CLIMAFAN



## Fan Code: 80AC/6/6/...

## 800 mm 935 rev/min 6 Blades 50 Hz

### Performance Data

#### BS 848 Pt 1 1980

Performance shown is specifically for non-ducted installations.

### Sound Data

#### BS 848 Pt 2 1985

Single figures on performance curves are overall inlet sound power levels, "A" weighted ( $L_{WA}$  re: 1 pW), derived from measurements taken in Woods laboratory specifically under non-ducted free field conditions. For sound power levels in eight octave bands, apply the following corrections to the overall level:

#### Inlet Levels

	Pitch Angle	Frequency Hz							
		63	125	250	500	1K	2K	4K	8K
$L_{WA}$	8 - 18	-36	-22	-12	-5	-4	-8	-13	-22
$L_W$	8 - 18	-10	-6	-3	-2	-4	-9	-14	-21
$L_{WA}$	20 - 36	-29	-19	-11	-6	-5	-7	-10	-15
$L_W$	20 - 36	-3	-3	-2	-3	-5	-8	-11	-14

#### Outlet Levels

	Pitch Angle	Frequency Hz							
		63	125	250	500	1K	2K	4K	8K
$L_{WA}$	8 - 18	-31	-15	-6	-2	-2	-6	-11	-19
$L_W$	8 - 18	-5	+1	+3	+1	-2	-7	-12	-18
$L_{WA}$	20 - 36	-24	-11	-4	-3	-3	-5	-8	-12
$L_W$	20 - 36	+2	+5	+5	0	-3	-6	-9	-11

Extra performance only from plate mounted fans.

Three blade performance available. See chart number 27.

### Electrical Data

220-240 V / 50 Hz / 1  $\phi$

Motor	Fixed Speed				Speed Controllable					
	Pitch Angle (°)	Motor Rating (kW)	Full Load (A)	Starting Current (A)	Pitch Angle (°)	Motor Rating (kW)	Full Load (A)	Starting Current (A)	Speed Controller	
									Electronic	Auto-Transformer
CT9	12 - 14	0.68	5.2	6.5	-	-	-	-	-	-
F2265	20 - 30	1.55	9.8	27	22 - 26	1.35	8.7	27	ME1.10	-
F2269	34 - 36	2.5	16	48	34 - 36	2.1	13	39	-	-

380-420 V / 50 Hz / 3  $\phi$

Motor	Fixed Speed				Speed Controllable					
	Pitch Angle (°)	Motor Rating (kW)	Full Load (A)	Starting Current (A)	Pitch Angle (°)	Motor Rating (kW)	Full Load (A)	Starting Current (A)	Speed Control	
									Electronic	$\Delta/\Lambda$ * Pitch Angle
CT9	8 - 14	0.68	2.2	7.5	10	0.52	1.7	7.5	ME3.2D	10
F2265	16 - 30	1.55	4	15	22 - 26	1.35	3.6	15	-	26
F2269	32 - 36	2.5	6.3	26	32 - 36	2.1	5.5	26	-	-

\* By connecting these 3 phase motors in star ( $\Lambda$ ), a second speed will be obtained approximately 80% of the full speed at the angle shown. (A Woods two speed switch type MDS3.10 is available). For dimensions and weights of this fan please refer to pages 54 and 55.

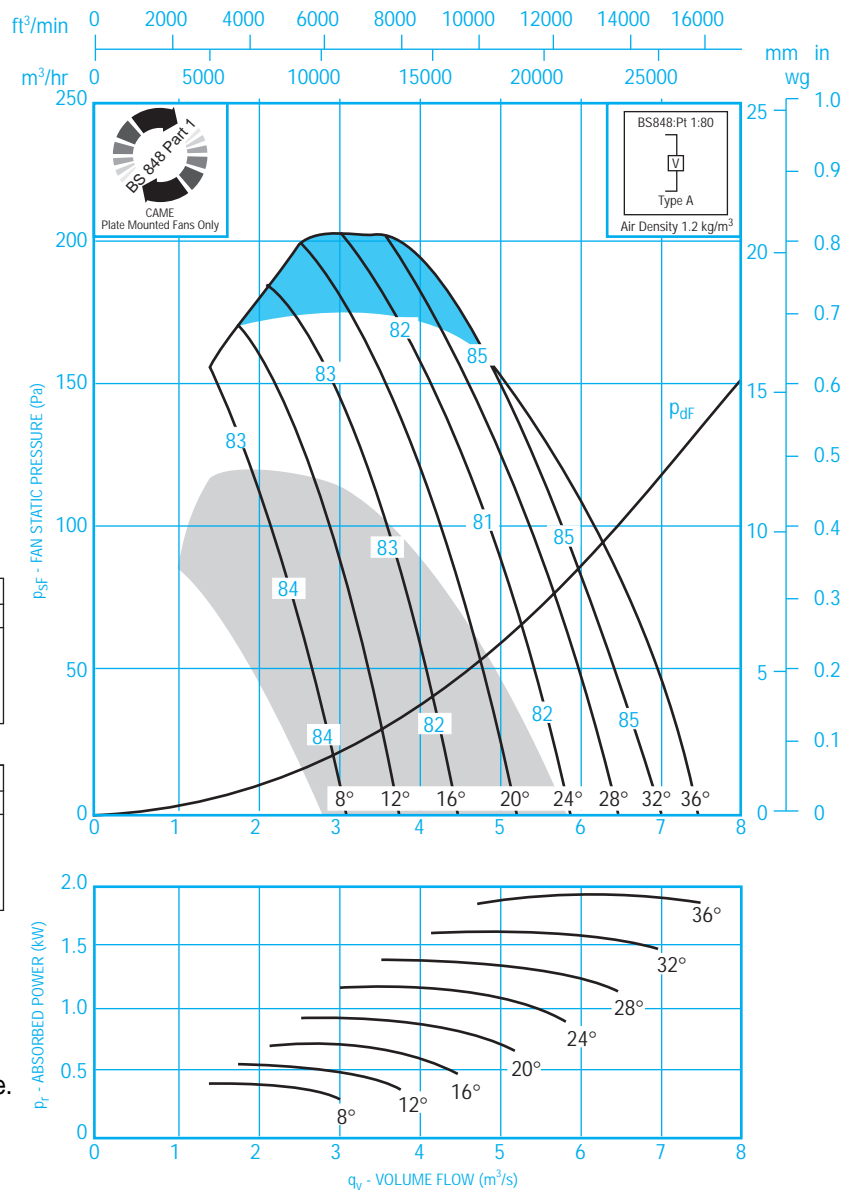

Chart No. 28

# AEROFOIL CLIMAFAN



## Fan Code: 80AC/4/3/...

## 800 mm 1440 rev/min 3 Blades 50 Hz



### Performance Data

#### BS 848 Pt 1 1980

Performance shown is specifically for non-ducted installations.

### Sound Data

#### BS 848 Pt 2 1985

Single figures on performance curves are overall inlet sound power levels, "A" weighted ( $L_{WA}$  re: 1 pW), derived from measurements taken in Woods laboratory specifically under non-ducted free field conditions. For sound power levels in eight octave bands, apply the following corrections to the overall level:

#### Inlet Levels

	Pitch Angle	Frequency Hz							
		63	125	250	500	1K	2K	4K	8K
$L_{WA}$	8 - 18	-31	-21	-10	-5	-6	-8	-11	-18
$L_W$	8 - 18	-5	-5	-1	-2	-6	-9	-12	-17
$L_{WA}$	20 - 32	-26	-17	-10	-6	-6	-8	-9	-13
$L_W$	20 - 32	0	-1	-1	-3	-6	-9	-10	-12

#### Outlet Levels

	Pitch Angle	Frequency Hz							
		63	125	250	500	1K	2K	4K	8K
$L_{WA}$	8 - 18	-25	-18	-7	-3	-4	-6	-9	-15
$L_W$	8 - 18	+1	-2	+2	0	-4	-7	-10	-14
$L_{WA}$	20 - 32	-21	-15	-6	-4	-4	-6	-7	-11
$L_W$	20 - 32	+5	+1	+3	-1	-4	-7	-8	-10

Extra performance only from plate mounted fans.

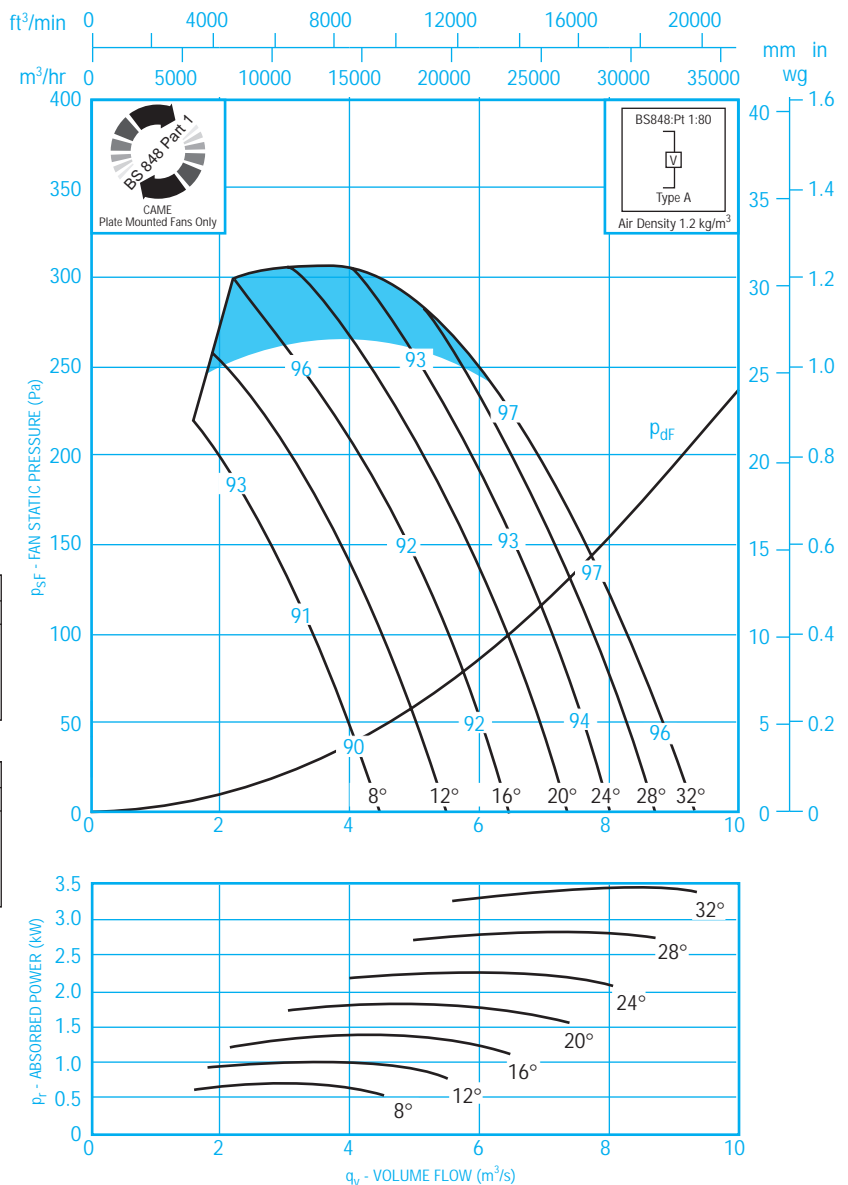

### Electrical Data

220-240 V / 50 Hz / 1  $\phi$

Chart No. 29

Motor	Fixed Speed				Speed Controllable					
	Pitch Angle (°)	Motor Rating (kW)	Full Load (A)	Starting Current (A)	Pitch Angle (°)	Motor Rating (kW)	Full Load (A)	Starting Current (A)	Speed Controller	
									Electronic	Auto-Transformer
CT9	10 - 12	1.3	8.2	23	-	-	-	-	-	-
F2245	16 - 18	2	11	35	16	1.7	10	33	-	-
F2249	22 - 28	3.2	18	62	-	-	-	-	-	-

380-420 V / 50 Hz / 3  $\phi$

Motor	Fixed Speed				Speed Controllable					
	Pitch Angle (°)	Motor Rating (kW)	Full Load (A)	Starting Current (A)	Pitch Angle (°)	Motor Rating (kW)	Full Load (A)	Starting Current (A)	Speed Control	
									Electronic	$\Delta/\Lambda$ * Pitch Angle
CT9	8 - 12	1.4	3.5	14	10	1.15	3	11.4	ME3.2D	10
F2245	14 - 24	2.7	5.8	30	18 - 20	2.1	4.7	30	-	20
F2249	26 - 32	4.4	9.3	54	-	-	-	-	-	-

\* By connecting these 3 phase motors in star ( $\Lambda$ ), a second speed will be obtained approximately 80% of the full speed at the angle shown. (A Woods two speed switch type MDS3.10 is available). For dimensions and weights of this fan please refer to pages 54 and 55.

# AEROFOIL CLIMAFAN



## Fan Code: 80AC/4/6/...

## 800 mm 1440 rev/min 6 Blades 50 Hz

### Performance Data

#### BS 848 Pt 1 1980

Performance shown is specifically for non-ducted installations.

### Sound Data

#### BS 848 Pt 2 1985

Single figures on performance curves are overall inlet sound power levels, "A" weighted ( $L_{WA}$  re: 1 pW), derived from measurements taken in Woods laboratory specifically under non-ducted free field conditions. For sound power levels in eight octave bands, apply the following corrections to the overall level:

#### Inlet Levels

	Pitch Angle	Frequency Hz							
		63	125	250	500	1K	2K	4K	8K
$L_{WA}$	8 - 18	-38	-26	-16	-7	-4	-6	-11	-19
$L_W$	8 - 18	-12	-10	-7	-4	-4	-7	-12	-18
$L_{WA}$	20 - 36	-36	-19	-13	-7	-5	-6	-9	-14
$L_W$	20 - 36	-10	-3	-4	-4	-5	-7	-10	-13

#### Outlet Levels

	Pitch Angle	Frequency Hz							
		63	125	250	500	1K	2K	4K	8K
$L_{WA}$	8 - 18	-34	-18	-9	-2	-1	-4	-9	-16
$L_W$	8 - 18	-8	-2	0	+1	-1	-5	-10	-15
$L_{WA}$	20 - 36	-31	-12	-6	-2	-2	-4	-7	-12
$L_W$	20 - 36	-5	+4	+3	+1	-2	-5	-8	-11

Extra performance only from plate mounted fans.

Three blade performance available. See chart number 29.

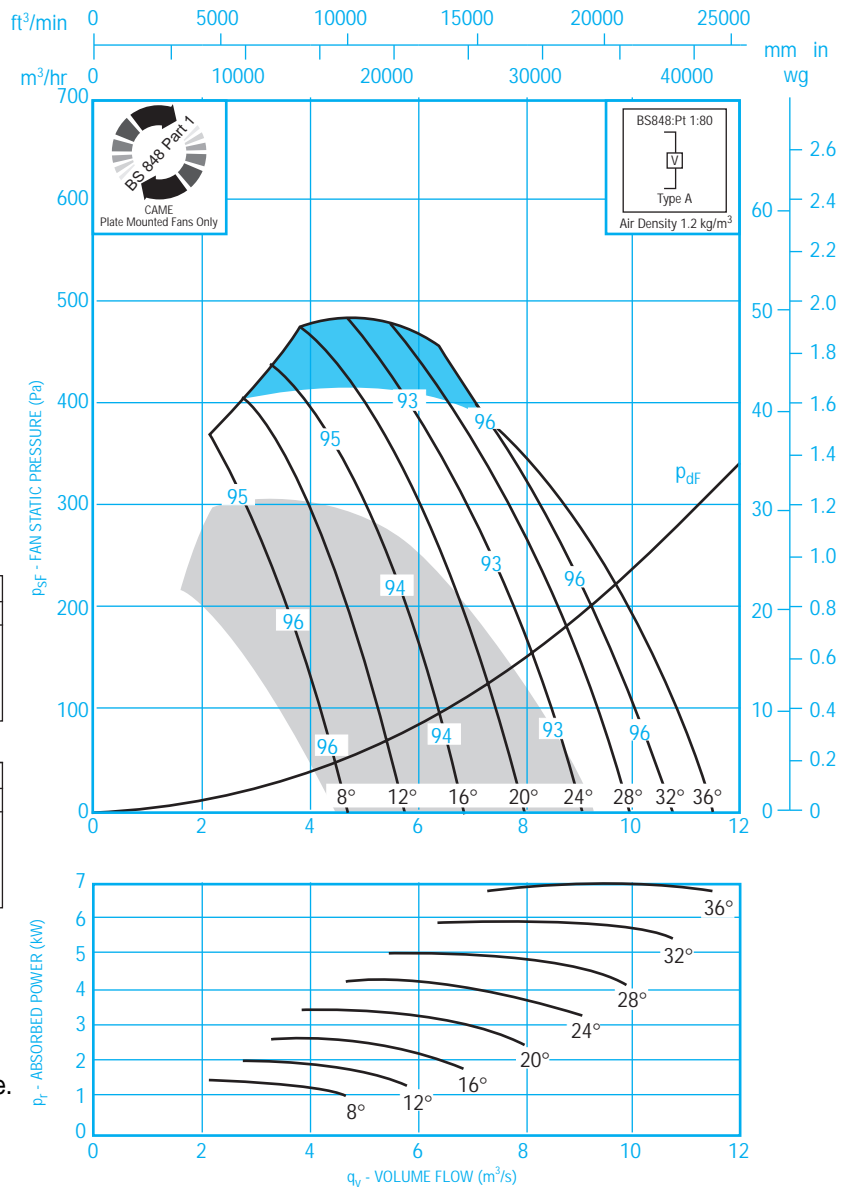

### Electrical Data

220-240 V / 50 Hz / 1  $\phi$

Chart No. 30

Motor	Fixed Speed				Speed Controllable					
	Pitch Angle (°)	Motor Rating (kW)	Full Load (A)	Starting Current (A)	Pitch Angle (°)	Motor Rating (kW)	Full Load (A)	Starting Current (A)	Speed Controller	
									Electronic	Auto-Transformer
F2245	10	2	11	35	-	-	-	-	-	-
F2249	14 - 18	3.2	18	62	-	-	-	-	-	-
-	-	-	-	-	-	-	-	-	-	-

380-420 V / 50 Hz / 3  $\phi$

Motor	Fixed Speed				Speed Controllable					
	Pitch Angle (°)	Motor Rating (kW)	Full Load (A)	Starting Current (A)	Pitch Angle (°)	Motor Rating (kW)	Full Load (A)	Starting Current (A)	Speed Control	
									Electronic	$\Delta/\Lambda$ * Pitch Angle
F2245	8 - 14	2.7	5.8	30	10 - 12	2.1	4.7	30	-	12
F2249	16 - 24	4.4	9.3	52	-	-	-	-	-	-
-	-	-	-	-	-	-	-	-	-	-

\* By connecting these 3 phase motors in star ( $\Lambda$ ), a second speed will be obtained approximately 80% of the full speed at the angle shown. (A Woods two speed switch type MDS3.10 is available). For dimensions and weights of this fan please refer to pages 54 and 55.



# AEROFOIL CLIMAFAN



## Fan Code: 90AC/10/3/...

## 900 mm 550 rev/min 3 Blades 50 Hz



### Performance Data

#### BS 848 Pt 1 1980

Performance shown is specifically for non-ducted installations.

### Sound Data

#### BS 848 Pt 2 1985

Single figures on performance curves are overall inlet sound power levels, "A" weighted ( $L_{WA}$  re: 1 pW), derived from measurements taken in Woods laboratory specifically under non-ducted free field conditions. For sound power levels in eight octave bands, apply the following corrections to the overall level:

#### Inlet Levels

	Pitch Angle	Frequency Hz							
		63	125	250	500	1K	2K	4K	8K
$L_{WA}$	8 - 18	-28	-16	-8	-5	-5	-9	-13	-21
$L_W$	8 - 18	-2	0	+1	-2	-5	-10	-14	-20
$L_{WA}$	20 - 32	-25	-14	-9	-5	-6	-8	-10	-16
$L_W$	20 - 32	+1	+2	0	-2	-6	-9	-11	-15

#### Outlet Levels

	Pitch Angle	Frequency Hz							
		63	125	250	500	1K	2K	4K	8K
$L_{WA}$	8 - 18	-24	-13	-6	-3	-3	-7	-11	-18
$L_W$	8 - 18	+2	+3	+3	0	-3	-8	-12	-17
$L_{WA}$	20 - 32	-21	-12	-6	-3	-4	-5	-8	-14
$L_W$	20 - 32	+5	+4	+3	0	-4	-6	-9	-13

Extra performance only from plate mounted fans.

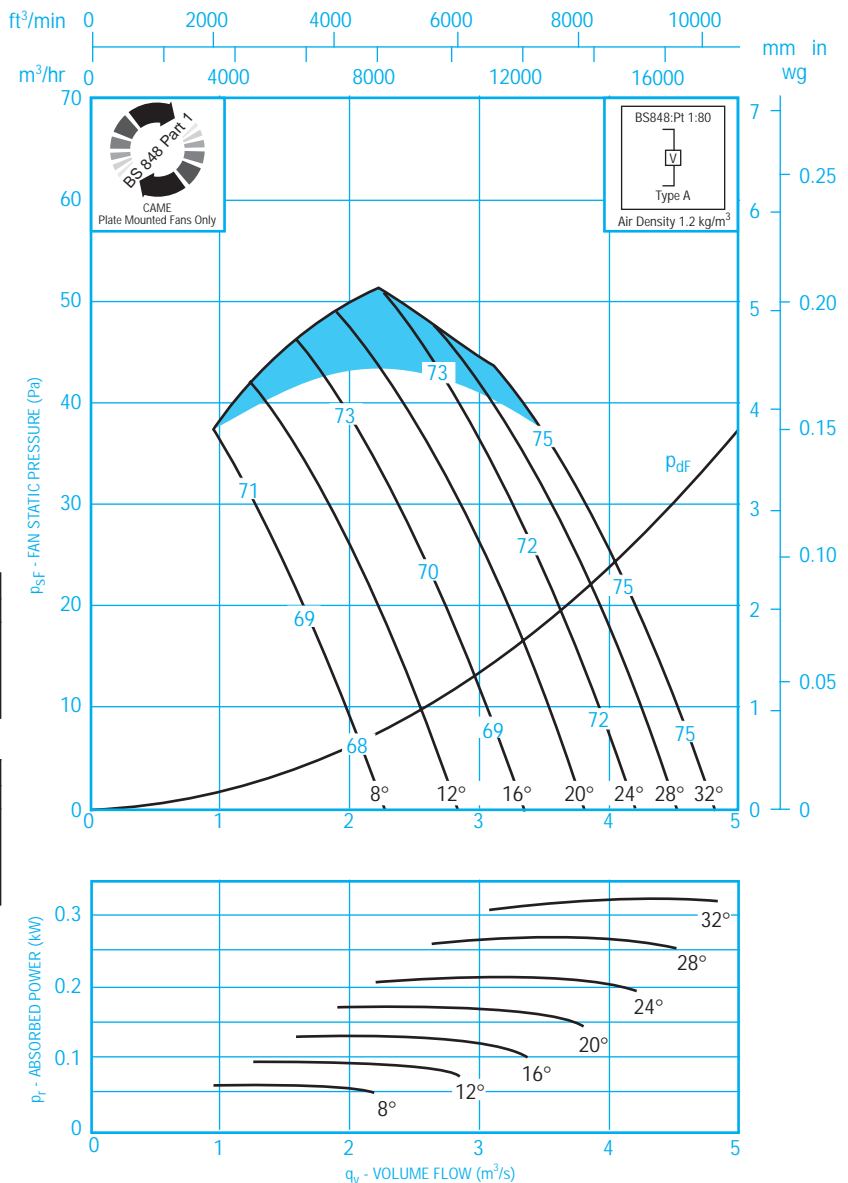

### Electrical Data

220-240 V / 50 Hz / 1  $\phi$

Chart No. 31

Motor	Fixed Speed				Speed Controllable					
	Pitch Angle (°)	Motor Rating (kW)	Full Load (A)	Starting Current (A)	Pitch Angle (°)	Motor Rating (kW)	Full Load (A)	Starting Current (A)	Speed Controller	
									Electronic	Auto-Transformer
CT9	12 - 16	0.14	1.7	2.6	10 - 12	0.1	1.3	1.8	ME1.3	MT1.5
F2265	30 - 32	0.4	3.4	4.6	30 - 32	0.33	2.9	4.1	ME1.3	MT1.5
-	-	-	-	-	-	-	-	-	-	-

380-420 V / 50 Hz / 3  $\phi$

Motor	Fixed Speed				Speed Controllable					
	Pitch Angle (°)	Motor Rating (kW)	Full Load (A)	Starting Current (A)	Pitch Angle (°)	Motor Rating (kW)	Full Load (A)	Starting Current (A)	Speed Control	
									Electronic	$\Delta/\Lambda$ * Pitch Angle
CT9	8 - 16	0.14	0.9	1.6	10 - 12	0.1	0.7	1.3	ME3.2D	12
F2265	18 - 32	0.4	1.9	3.8	28 - 32	0.33	1.7	3.8	ME3.2D	32
-	-	-	-	-	-	-	-	-	-	-

\* By connecting these 3 phase motors in star ( $\Lambda$ ), a second speed will be obtained approximately 80% of the full speed at the angle shown. (A Woods two speed switch type MDS3.10 is available). For dimensions and weights of this fan please refer to pages 54 and 55.

# AEROFOIL CLIMAFAN



## Fan Code: 90AC/10/6/...

## 900 mm 550 rev/min 6 Blades 50 Hz

### Performance Data

#### BS 848 Pt 1 1980

Performance shown is specifically for non-ducted installations.

### Sound Data

#### BS 848 Pt 2 1985

Single figures on performance curves are overall inlet sound power levels, "A" weighted ( $L_{WA}$  re: 1 pW), derived from measurements taken in Woods laboratory specifically under non-ducted free field conditions. For sound power levels in eight octave bands, apply the following corrections to the overall level:

#### Inlet Levels

	Pitch Angle	Frequency Hz							
		63	125	250	500	1K	2K	4K	8K
$L_{WA}$	8 - 18	-28	-16	-8	-4	-5	-10	-16	-25
$L_W$	8 - 18	-2	0	+1	-1	-5	-11	-17	-24
$L_{WA}$	20 - 36	-25	-14	-9	-5	-5	-7	-11	-18
$L_W$	20 - 36	+1	+2	0	-2	-5	-8	-12	-17

#### Outlet Levels

	Pitch Angle	Frequency Hz							
		63	125	250	500	1K	2K	4K	8K
$L_{WA}$	8 - 18	-21	-11	-5	-2	-3	-8	-14	-21
$L_W$	8 - 18	+5	+5	+4	+1	-3	-9	-15	-20
$L_{WA}$	20 - 36	-18	-9	-6	-3	-3	-5	-9	-14
$L_W$	20 - 36	+8	+7	+3	0	-3	-6	-10	-13

Extra performance only from plate mounted fans.

Three blade performance available. See chart number 31.

### Electrical Data

220-240 V / 50 Hz / 1  $\phi$

Chart No. 32

Motor	Fixed Speed				Speed Controllable					
	Pitch Angle (°)	Motor Rating (kW)	Full Load (A)	Starting Current (A)	Pitch Angle (°)	Motor Rating (kW)	Full Load (A)	Starting Current (A)	Speed Controller	
									Electronic	Auto-Transformer
CT9	14 - 18	0.3	2.7	3.5	14	0.25	2.3	3.4	ME1.6	MT1.5
F2265	30 - 32	0.8	5.9	12	24 - 32	0.65	4.9	12	ME1.6	MT1.8
-	-	-	-	-	-	-	-	-	-	-

380-420 V / 50 Hz / 3  $\phi$

Motor	Fixed Speed				Speed Controllable					
	Pitch Angle (°)	Motor Rating (kW)	Full Load (A)	Starting Current (A)	Pitch Angle (°)	Motor Rating (kW)	Full Load (A)	Starting Current (A)	Speed Control	
									Electronic	$\Delta/\Lambda$ * Pitch Angle
CT9	8 - 18	0.3	1.4	2.6	12 - 14	0.25	1.2	2.6	ME3.2D	14
F2265	20 - 32	0.8	2.8	8	24 - 32	0.65	2.4	8	ME3.2D	32
-	-	-	-	-	-	-	-	-	-	-

\* By connecting these 3 phase motors in star ( $\Lambda$ ), a second speed will be obtained approximately 80% of the full speed at the angle shown. (A Woods two speed switch type MDS3.10 is available). For dimensions and weights of this fan please refer to pages 54 and 55.

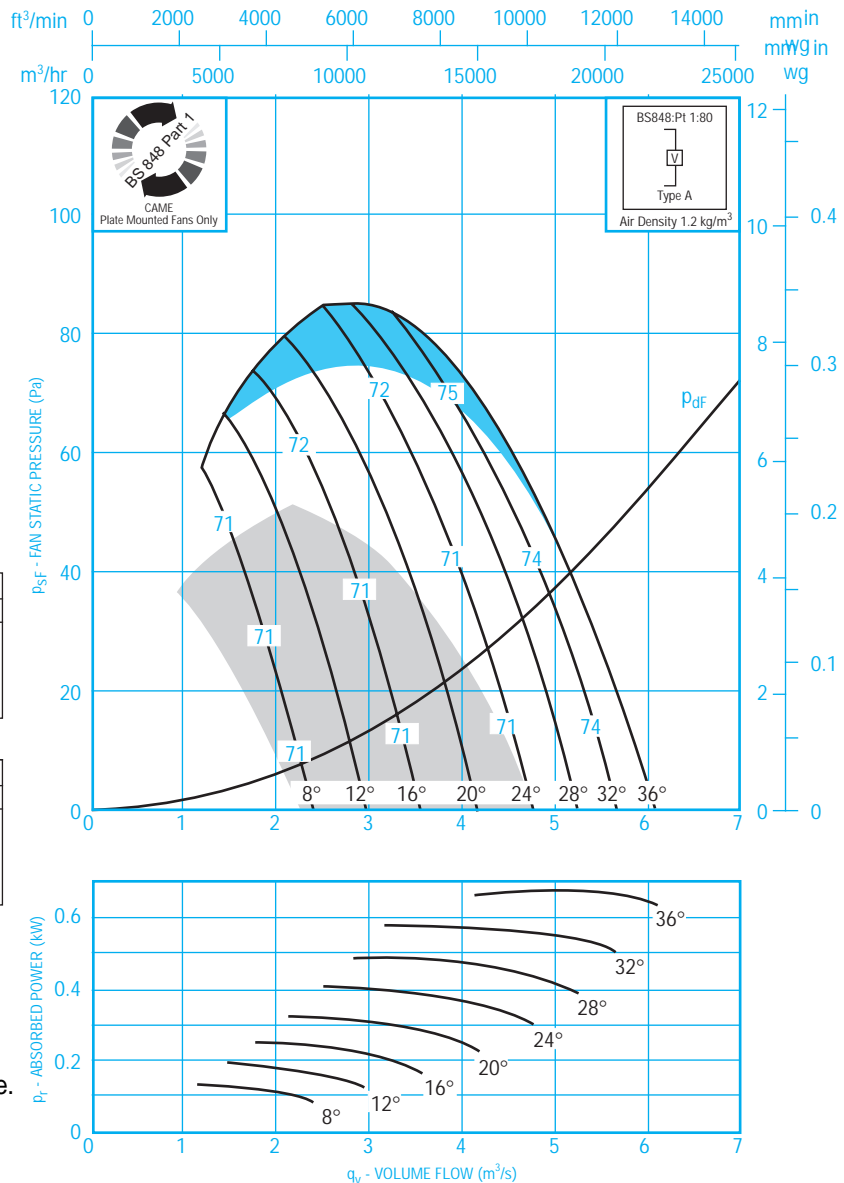

# AEROFOIL CLIMAFAN



## Fan Code: 90AC/8/3/...

## 900 mm 695 rev/min 3 Blades 50 Hz



### Performance Data

#### BS 848 Pt 1 1980

Performance shown is specifically for non-ducted installations.

### Sound Data

#### BS 848 Pt 2 1985

Single figures on performance curves are overall inlet sound power levels, "A" weighted ( $L_{WA}$  re: 1 pW), derived from measurements taken in Woods laboratory specifically under non-ducted free field conditions. For sound power levels in eight octave bands, apply the following corrections to the overall level:

#### Inlet Levels

	Pitch Angle	Frequency Hz							
		63	125	250	500	1K	2K	4K	8K
$L_{WA}$	8 - 18	-28	-16	-9	-5	-5	-9	-13	-21
$L_W$	8 - 18	-2	0	0	-2	-5	-10	-14	-20
$L_{WA}$	20 - 32	-25	-14	-9	-6	-6	-8	-10	-16
$L_W$	20 - 32	+1	+2	0	-3	-6	-9	-11	-15

#### Outlet Levels

	Pitch Angle	Frequency Hz							
		63	125	250	500	1K	2K	4K	8K
$L_{WA}$	8 - 18	-24	-13	-6	-3	-3	-7	-11	-18
$L_W$	8 - 18	+2	+3	+3	0	-3	-8	-12	-17
$L_{WA}$	20 - 32	-21	-11	-6	-4	-4	-6	-8	-14
$L_W$	20 - 32	+5	+5	+3	-1	-4	-7	-9	-13

Extra performance only from plate mounted fans.

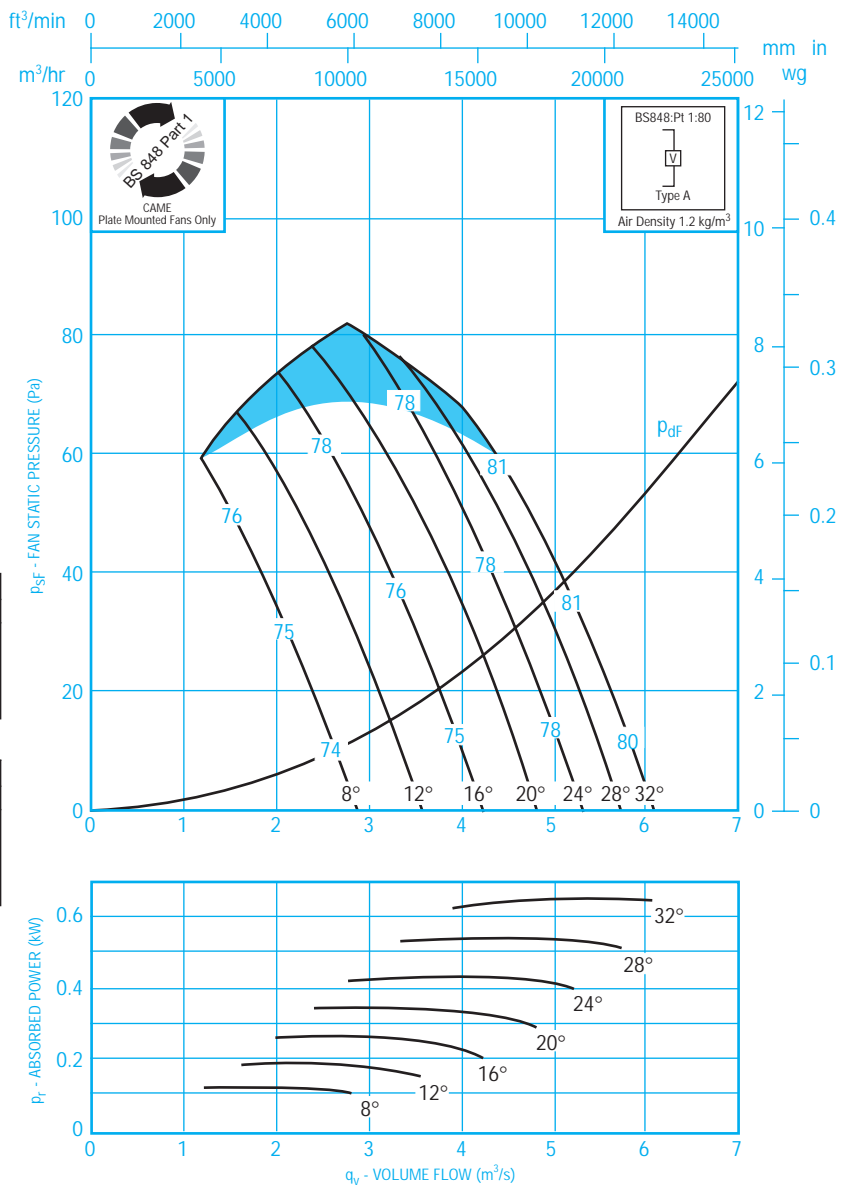

### Electrical Data

220-240 V / 50 Hz / 1  $\phi$

Chart No. 33

Motor	Fixed Speed				Speed Controllable					
	Pitch Angle (°)	Motor Rating (kW)	Full Load (A)	Starting Current (A)	Pitch Angle (°)	Motor Rating (kW)	Full Load (A)	Starting Current (A)	Speed Controller	
									Electronic	Auto-Transformer
CT9	14 - 18	0.3	2.7	3.5	20 - 22	0.25	2.3	3.4	ME1.6	MT1.5
F2265	30 - 32	0.8	5.9	12	24 - 32	0.65	4.9	12	ME1.6	MT1.8
-	-	-	-	-	-	-	-	-	-	-

380-420 V / 50 Hz / 3  $\phi$

Motor	Fixed Speed				Speed Controllable					
	Pitch Angle (°)	Motor Rating (kW)	Full Load (A)	Starting Current (A)	Pitch Angle (°)	Motor Rating (kW)	Full Load (A)	Starting Current (A)	Speed Control	
									Electronic	$\Delta/\Lambda$ * Pitch Angle
CT9	8 - 18	0.3	1.4	2.6	12 - 14	0.25	1.2	2.6	ME3.2D	14
F2265	20 - 32	0.8	2.8	8	24 - 32	0.65	2.4	8	ME3.2D	32
-	-	-	-	-	-	-	-	-	-	-

\* By connecting these 3 phase motors in star ( $\Lambda$ ), a second speed will be obtained approximately 80% of the full speed at the angle shown. (A Woods two speed switch type MDS3.10 is available). For dimensions and weights of this fan please refer to pages 54 and 55.

# AEROFOIL CLIMAFAN



## Fan Code: 90AC/8/6/...

## 900 mm 695 rev/min 6 Blades 50 Hz

### Performance Data

#### BS 848 Pt 1 1980

Performance shown is specifically for non-ducted installations.

### Sound Data

#### BS 848 Pt 2 1985

Single figures on performance curves are overall inlet sound power levels, "A" weighted ( $L_{WA}$  re: 1 pW), derived from measurements taken in Woods laboratory specifically under non-ducted free field conditions. For sound power levels in eight octave bands, apply the following corrections to the overall level:

#### Inlet Levels

	Pitch Angle	Frequency Hz							
		63	125	250	500	1K	2K	4K	8K
$L_{WA}$	8 - 18	-30	-18	-10	-4	-5	-9	-15	-24
$L_W$	8 - 18	-4	-2	-1	-1	-5	-10	-16	-23
$L_{WA}$	20 - 36	-25	-15	-10	-6	-5	-7	-11	-17
$L_W$	20 - 36	+1	+1	-1	-3	-5	-8	-12	-16

#### Outlet Levels

	Pitch Angle	Frequency Hz							
		63	125	250	500	1K	2K	4K	8K
$L_{WA}$	8 - 18	-23	-13	-6	-2	-3	-7	-13	-20
$L_W$	8 - 18	+3	+3	+3	+1	-3	-8	-14	-19
$L_{WA}$	20 - 36	-19	-11	-6	-3	-3	-5	-9	-14
$L_W$	20 - 36	+7	+5	+3	0	-3	-6	-10	-13

Extra performance only from plate mounted fans.

Three blade performance available. See chart number 33.

### Electrical Data

220-240 V / 50 Hz / 1  $\phi$

Chart No. 34

Motor	Fixed Speed				Speed Controllable					
	Pitch Angle (°)	Motor Rating (kW)	Full Load (A)	Starting Current (A)	Pitch Angle (°)	Motor Rating (kW)	Full Load (A)	Starting Current (A)	Speed Controller	
									Electronic	Auto-Transformer
F2265	18 - 24	0.8	5.9	12	14 - 20	0.65	4.9	12	ME1.6	MT1.8
F2269	30 - 36	1.4	10	20	28 - 30	1.1	8.2	19.5	ME1.10	MT1.8
-	-	-	-	-	-	-	-	-	-	-

380-420 V / 50 Hz / 3  $\phi$

Motor	Fixed Speed				Speed Controllable					
	Pitch Angle (°)	Motor Rating (kW)	Full Load (A)	Starting Current (A)	Pitch Angle (°)	Motor Rating (kW)	Full Load (A)	Starting Current (A)	Speed Control	
									Electronic	$\Delta/\lambda$ * Pitch Angle
F2265	8 - 22	0.8	2.8	8	14 - 20	0.65	2.4	8	ME3.2D	20
F2269	24 - 36	1.4	4.7	14	26 - 30	1.1	3.8	14	-	30
-	-	-	-	-	-	-	-	-	-	-

\* By connecting these 3 phase motors in star ( $\lambda$ ), a second speed will be obtained approximately 80% of the full speed at the angle shown. (A Woods two speed switch type MDS3.10 is available). For dimensions and weights of this fan please refer to pages 54 and 55.

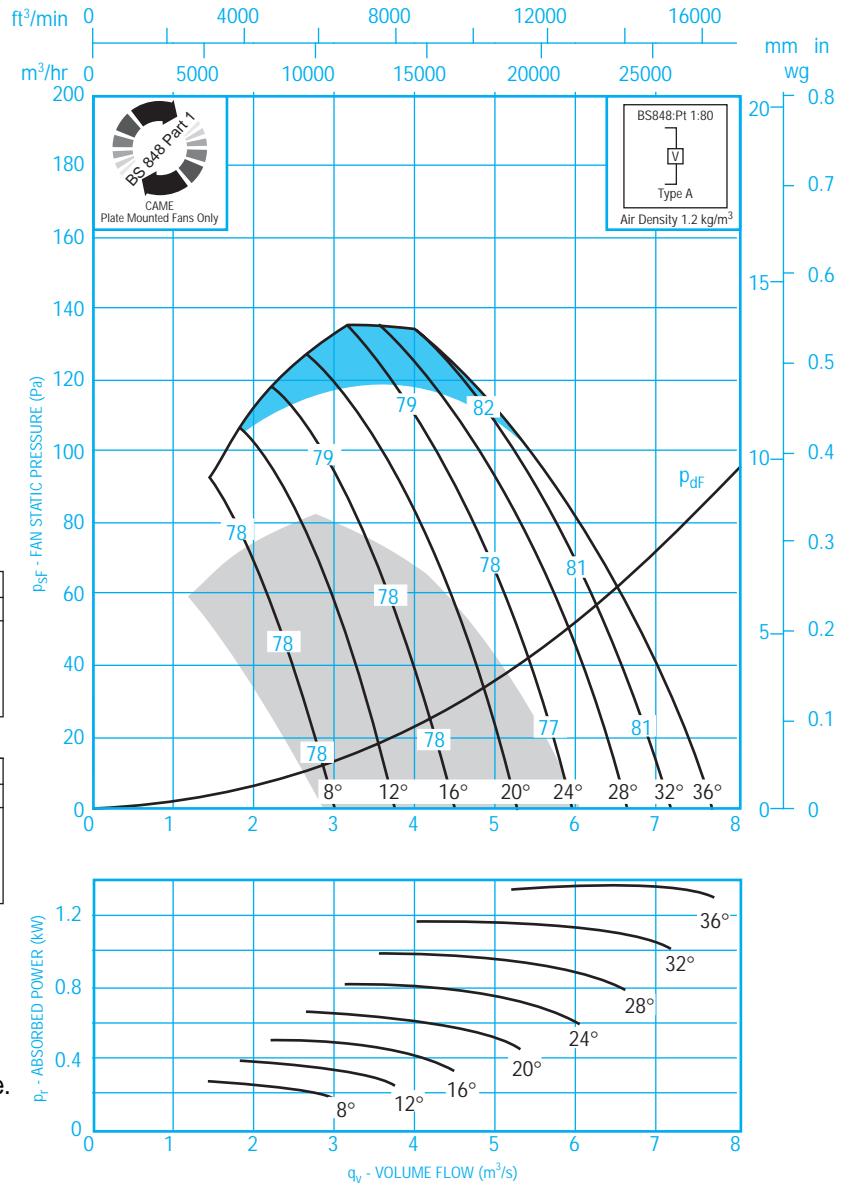

# AEROFOIL CLIMAFAN



## Fan Code: 90AC/6/3/...

## 900 mm 935 rev/min 3 Blades 50 Hz



### Performance Data

#### BS 848 Pt 1 1980

Performance shown is specifically for non-ducted installations.

### Sound Data

#### BS 848 Pt 2 1985

Single figures on performance curves are overall inlet sound power levels, "A" weighted ( $L_{WA}$  re: 1 pW), derived from measurements taken in Woods laboratory specifically under non-ducted free field conditions. For sound power levels in eight octave bands, apply the following corrections to the overall level:

#### Inlet Levels

	Pitch Angle	Frequency Hz							
		63	125	250	500	1K	2K	4K	8K
$L_{WA}$	8 - 18	-28	-16	-9	-5	-5	-9	-13	-21
$L_W$	8 - 18	-2	0	-2	-5	-10	-14	-20	
$L_{WA}$	20 - 32	-25	-14	-9	-6	-6	-8	-10	-16
$L_W$	20 - 32	+1	+2	0	-3	-6	-9	-11	-15

#### Outlet Levels

	Pitch Angle	Frequency Hz							
		63	125	250	500	1K	2K	4K	8K
$L_{WA}$	8 - 18	-24	-13	-6	-3	-3	-7	-11	-18
$L_W$	8 - 18	+2	+3	+3	0	-3	-8	-12	-17
$L_{WA}$	20 - 32	-21	-11	-6	-4	-4	-6	-8	-14
$L_W$	20 - 32	+5	+5	+3	-1	-4	-7	-9	-13

Extra performance only from plate mounted fans.

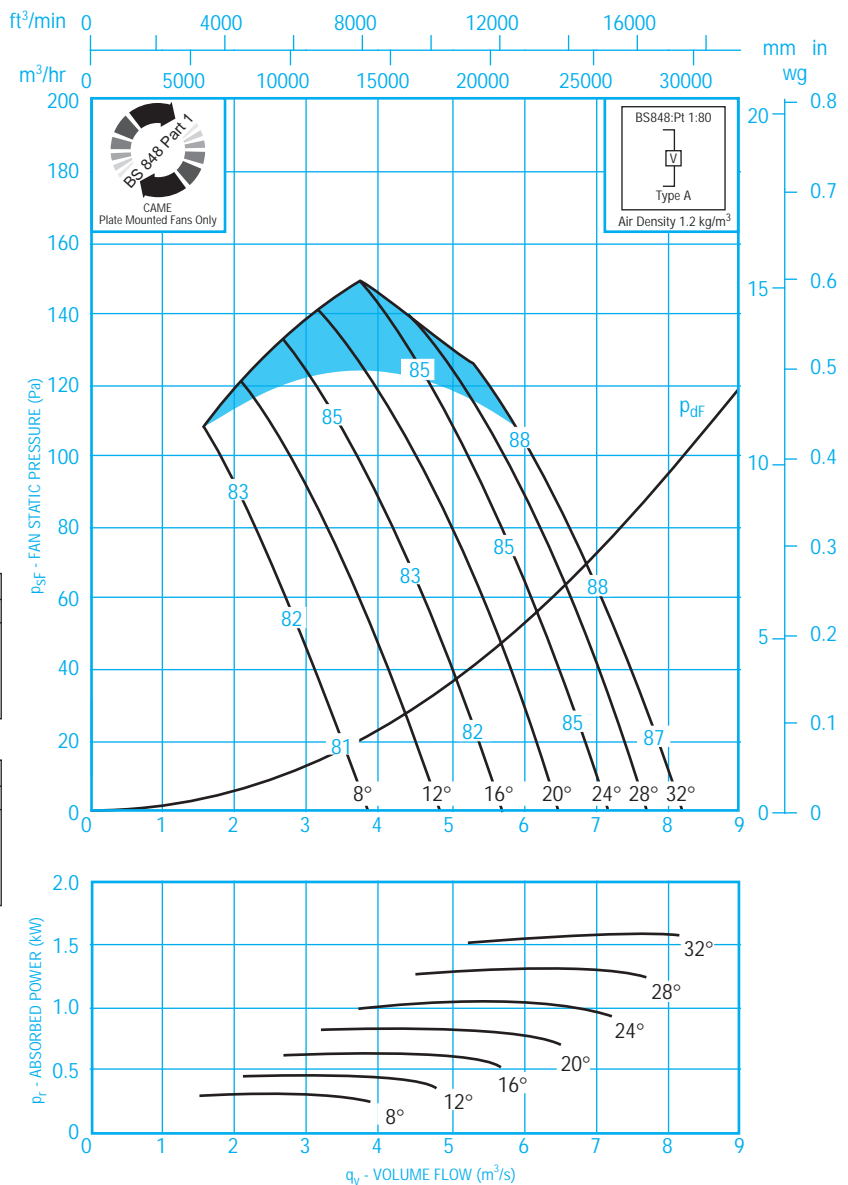

### Electrical Data

220-240 V / 50 Hz / 1  $\phi$

Chart No. 35

Motor	Fixed Speed				Speed Controllable					
	Pitch Angle (°)	Motor Rating (kW)	Full Load (A)	Starting Current (A)	Pitch Angle (°)	Motor Rating (kW)	Full Load (A)	Starting Current (A)	Speed Controller	
									Electronic	Auto-Transformer
CT9	14 - 16	0.68	5.2	6.5	-	-	-	-	-	-
F2265	22 - 30	1.55	9.8	27	24 - 28	1.35	8.7	27	ME1.10	-
-	-	-	-	-	-	-	-	-	-	-

380-420 V / 50 Hz / 3  $\phi$

Motor	Fixed Speed				Speed Controllable					
	Pitch Angle (°)	Motor Rating (kW)	Full Load (A)	Starting Current (A)	Pitch Angle (°)	Motor Rating (kW)	Full Load (A)	Starting Current (A)	Speed Control	
									Electronic	$\Delta/\Lambda$ * Pitch Angle
CT9	8 - 16	0.68	2.2	7.5	12	0.52	1.7	7.5	ME3.2D	12
F2265	18 - 30	1.55	4	15	24 - 28	1.35	3.6	15	-	28
F2269	32	2.5	6.3	26	-	-	-	-	-	-

\* By connecting these 3 phase motors in star ( $\Lambda$ ), a second speed will be obtained approximately 80% of the full speed at the angle shown. (A Woods two speed switch type MDS3.10 is available). For dimensions and weights of this fan please refer to pages 54 and 55.

# AEROFOIL CLIMAFAN



## Fan Code: 90AC/6/6/...

## 900 mm 935 rev/min 6 Blades 50 Hz

### Performance Data

#### BS 848 Pt 1 1980

Performance shown is specifically for non-ducted installations.

### Sound Data

#### BS 848 Pt 2 1985

Single figures on performance curves are overall inlet sound power levels, "A" weighted ( $L_{WA}$  re: 1 pW), derived from measurements taken in Woods laboratory specifically under non-ducted free field conditions. For sound power levels in eight octave bands, apply the following corrections to the overall level:

#### Inlet Levels

	Pitch Angle	Frequency Hz							
		63	125	250	500	1K	2K	4K	8K
$L_{WA}$	8 - 18	-35	-21	-12	-6	-4	-7	-13	-21
$L_{W}$	8 - 18	-9	-5	-3	-3	-4	-8	-14	-20
$L_{WA}$	20 - 36	-28	-18	-10	-6	-5	-7	-10	-16
$L_{W}$	20 - 36	-2	-2	-1	-3	-5	-8	-11	-15

#### Outlet Levels

	Pitch Angle	Frequency Hz							
		63	125	250	500	1K	2K	4K	8K
$L_{WA}$	8 - 18	-32	-15	-7	-2	-2	-5	-11	-19
$L_{W}$	8 - 18	-6	+1	+2	+1	-2	-6	-12	-18
$L_{WA}$	20 - 36	-26	-11	-5	-3	-3	-5	-8	-14
$L_{W}$	20 - 36	0	+5	+4	0	-3	-6	-9	-13

- Extra performance only from plate mounted fans.
- Three blade performance available. See chart number 35.

### Electrical Data

220-240 V / 50 Hz / 1  $\phi$

Chart No. 36

Motor	Fixed Speed				Speed Controllable					
	Pitch Angle (°)	Motor Rating (kW)	Full Load (A)	Starting Current (A)	Pitch Angle (°)	Motor Rating (kW)	Full Load (A)	Starting Current (A)	Speed Controller	
									Electronic	Auto-Transformer
F2265	12 - 18	1.55	9.8	27	14 - 16	1.35	8.7	27	ME1.10	-
F2269	22 - 28	2.5	16	48	22 - 24	2.1	13	39	-	-
-	-	-	-	-	-	-	-	-	-	-

380-420 V / 50 Hz / 3  $\phi$

Motor	Fixed Speed				Speed Controllable					
	Pitch Angle (°)	Motor Rating (kW)	Full Load (A)	Starting Current (A)	Pitch Angle (°)	Motor Rating (kW)	Full Load (A)	Starting Current (A)	Speed Control	
									Electronic	$\Delta/\lambda$ * Pitch Angle
F2265	8 - 18	1.55	4	15	14 - 16	1.35	3.6	15	-	16
F2269	20 - 28	2.5	6.3	26	22 - 24	2.1	5.5	26	-	24
-	-	-	-	-	-	-	-	-	-	-

\* By connecting these 3 phase motors in star ( $\lambda$ ), a second speed will be obtained approximately 80% of the full speed at the angle shown. (A Woods two speed switch type MDS3.10 is available). For dimensions and weights of this fan please refer to pages 54 and 55.

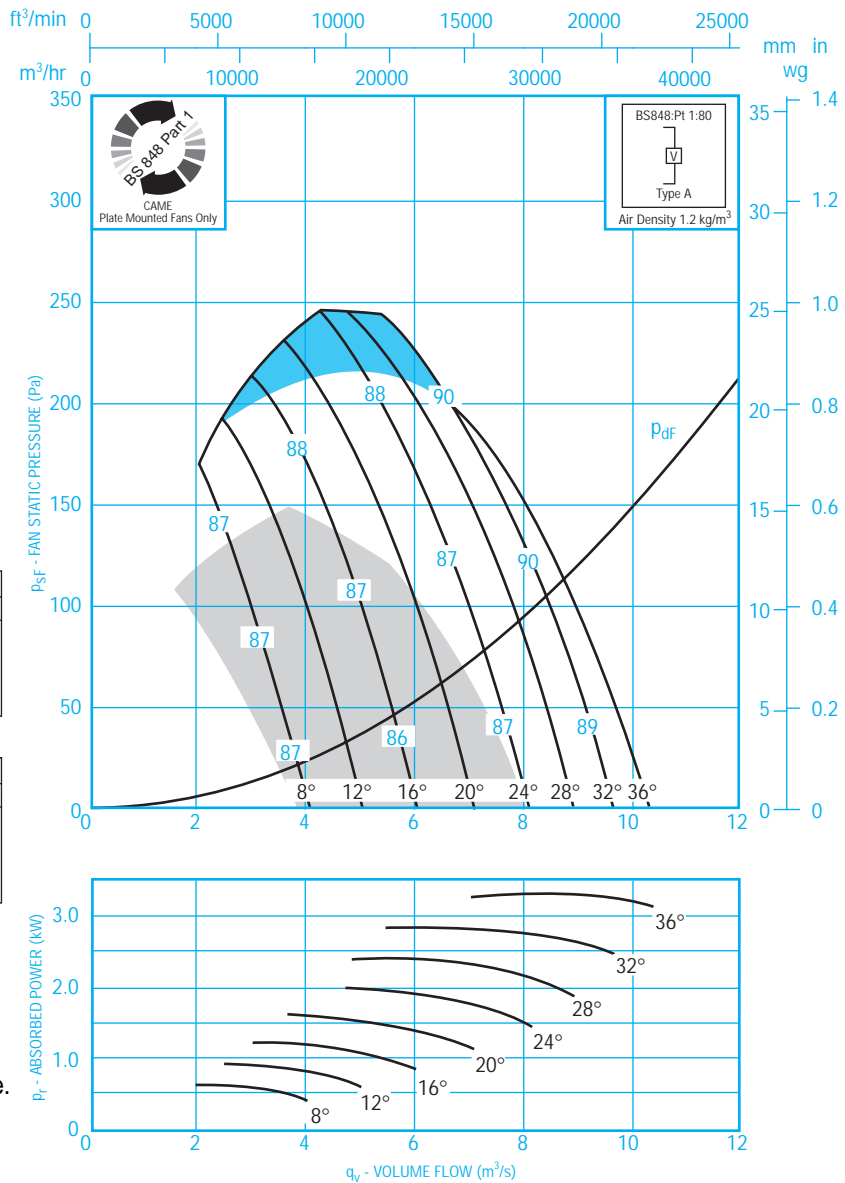



# AEROFOIL CLIMAFAN



## Fan Code: 100AC/10/3/...



## 1000 mm 550 rev/min 3 Blades 50 Hz

### Performance Data

#### BS 848 Pt 1 1980

Performance shown is specifically for non-ducted installations.

### Sound Data

#### BS 848 Pt 2 1985

Single figures on performance curves are overall inlet sound power levels, "A" weighted ( $L_{WA}$  re: 1 pW), derived from measurements taken in Woods laboratory specifically under non-ducted free field conditions. For sound power levels in eight octave bands, apply the following corrections to the overall level:

#### Inlet Levels

	Pitch Angle	Frequency Hz							
		63	125	250	500	1K	2K	4K	8K
$L_{WA}$	8 - 18	-26	-16	-9	-5	-5	-9	-15	-23
$L_W$	8 - 18	0	0	0	-2	-5	-10	-16	-22
$L_{WA}$	20 - 32	-25	-13	-10	-4	-6	-9	-12	-19
$L_W$	20 - 32	+1	+3	-1	-1	-6	-10	-13	-18

#### Outlet Levels

	Pitch Angle	Frequency Hz							
		63	125	250	500	1K	2K	4K	8K
$L_{WA}$	8 - 18	-22	-13	-7	-3	-3	-7	-12	-20
$L_W$	8 - 18	+4	+3	+2	0	-3	-8	-13	-19
$L_{WA}$	20 - 32	-21	-11	-7	-2	-4	-7	-10	-16
$L_W$	20 - 32	+5	+5	+2	+1	-4	-8	-11	-15

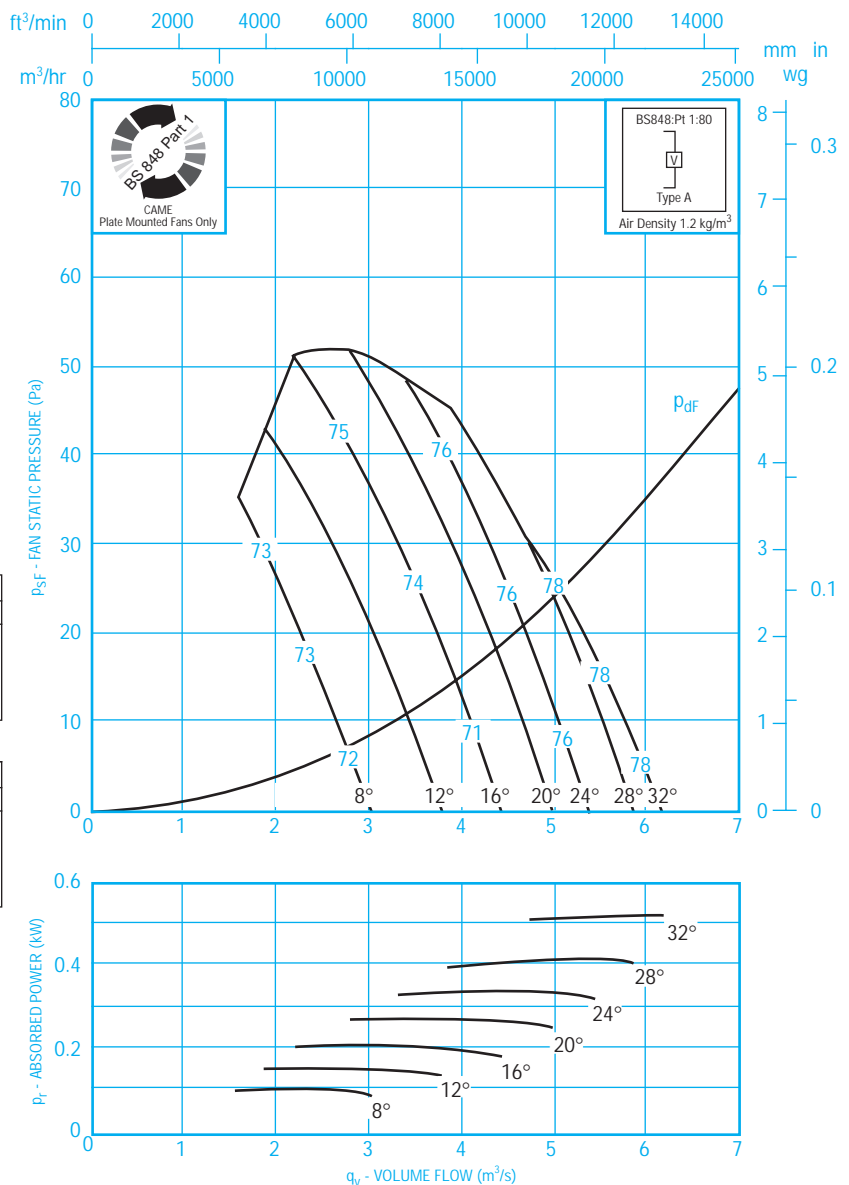

### Electrical Data

220-240 V / 50 Hz / 1  $\phi$

Chart No. 37

Motor	Fixed Speed				Speed Controllable					
	Pitch Angle (°)	Motor Rating (kW)	Full Load (A)	Starting Current (A)	Pitch Angle (°)	Motor Rating (kW)	Full Load (A)	Starting Current (A)	Speed Controller	
									Electronic	Auto-Transformer
F2265	22 - 26	0.4	3.4	4.6	20 - 22	0.33	2.9	4.1	ME1.3	MT1.5
F2269	34 - 36	0.7	5.7	8	28 - 34	0.55	4.7	6.6	ME1.6	MT1.5
-	-	-	-	-	-	-	-	-	-	-

380-420 V / 50 Hz / 3  $\phi$

Motor	Fixed Speed				Speed Controllable					
	Pitch Angle (°)	Motor Rating (kW)	Full Load (A)	Starting Current (A)	Pitch Angle (°)	Motor Rating (kW)	Full Load (A)	Starting Current (A)	Speed Control	
									Electronic	$\Delta/\Lambda$ * Pitch Angle
F2265	8 - 26	0.4	1.9	3.8	20 - 22	0.33	1.7	3.8	ME3.2D	22
F2269	28 - 36	0.7	3.3	8	28 - 34	0.55	2.7	6	ME3.2D	34
-	-	-	-	-	-	-	-	-	-	-

\* By connecting these 3 phase motors in star ( $\Lambda$ ), a second speed will be obtained approximately 80% of the full speed at the angle shown. (A Woods two speed switch type MDS3.10 is available). For dimensions and weights of this fan please refer to pages 54 and 55.

# AEROFOIL CLIMAFAN



## Fan Code: 100AC/10/6/...

## 1000 mm 550 rev/min 6 Blades 50 Hz

### Performance Data

#### BS 848 Pt 1 1980

Performance shown is specifically for non-ducted installations.

### Sound Data

#### BS 848 Pt 2 1985

Single figures on performance curves are overall inlet sound power levels, "A" weighted ( $L_{WA}$  re: 1 pW), derived from measurements taken in Woods laboratory specifically under non-ducted free field conditions. For sound power levels in eight octave bands, apply the following corrections to the overall level:

#### Inlet Levels

	Pitch Angle	Frequency Hz							
		63	125	250	500	1K	2K	4K	8K
$L_{WA}$	8 - 18	-25	-15	-9	-4	-5	-10	-16	-24
$L_W$	8 - 18	+1	+1	0	-1	-5	-11	-17	-23
$L_{WA}$	20 - 36	-23	-13	-9	-5	-6	-8	-12	-18
$L_W$	20 - 36	+3	+3	0	-2	-6	-9	-13	-17

#### Outlet Levels

	Pitch Angle	Frequency Hz							
		63	125	250	500	1K	2K	4K	8K
$L_{WA}$	8 - 18	-19	-12	-6	-3	-3	-8	-13	-21
$L_W$	8 - 18	+7	+4	+3	0	-3	-9	-14	-20
$L_{WA}$	20 - 36	-17	-10	-6	-4	-4	-6	-10	-16
$L_W$	20 - 36	+9	+6	+3	-1	-4	-7	-11	-15

Three blade performance available. See chart number 37.

### Electrical Data

220-240 V / 50 Hz / 1  $\phi$

Chart No. 38

Motor	Fixed Speed				Speed Controllable					
	Pitch Angle (°)	Motor Rating (kW)	Full Load (A)	Starting Current (A)	Pitch Angle (°)	Motor Rating (kW)	Full Load (A)	Starting Current (A)	Speed Controller	
									Electronic	Auto-Transformer
F2265	14	0.4	3.4	4.6	10 - 12	0.33	2.9	4.1	ME1.3	MT1.5
F2269	20 - 24	0.7	5.7	8	18 - 20	0.55	4.7	6.6	ME1.6	MT1.5
-	-	-	-	-	-	-	-	-	-	-

380-420 V / 50 Hz / 3  $\phi$

Motor	Fixed Speed				Speed Controllable					
	Pitch Angle (°)	Motor Rating (kW)	Full Load (A)	Starting Current (A)	Pitch Angle (°)	Motor Rating (kW)	Full Load (A)	Starting Current (A)	Speed Control	
									Electronic	$\Delta/\Delta$ * Pitch Angle
F2265	8 - 14	0.4	1.9	3.8	10 - 12	0.33	1.7	3.8	ME3.2D	12
F2269	16 - 24	0.7	3.3	8	18 - 20	0.55	2.7	6	ME3.2D	20
-	-	-	-	-	-	-	-	-	-	-

\* By connecting these 3 phase motors in star ( $\Delta$ ), a second speed will be obtained approximately 80% of the full speed at the angle shown. (A Woods two speed switch type MDS3.10 is available). For dimensions and weights of this fan please refer to pages 54 and 55.

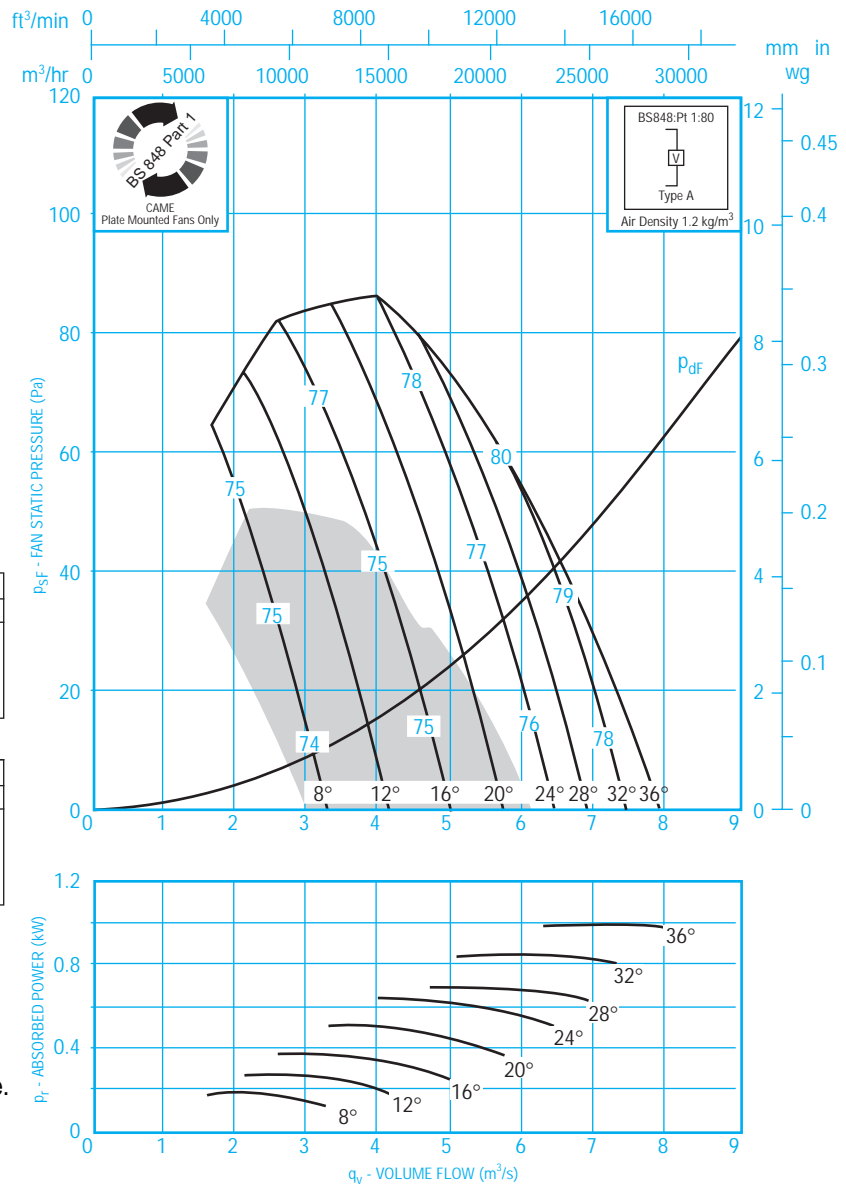

# AEROFOIL CLIMAFAN



## Fan Code: 100AC/8/3/...



## 1000 mm 695 rev/min 3 Blades 50 Hz

### Performance Data

#### BS 848 Pt 1 1980

Performance shown is specifically for non-ducted installations.

### Sound Data

#### BS 848 Pt 2 1985

Single figures on performance curves are overall inlet sound power levels, "A" weighted ( $L_{WA}$  re: 1 pW), derived from measurements taken in Woods laboratory specifically under non-ducted free field conditions. For sound power levels in eight octave bands, apply the following corrections to the overall level:

#### Inlet Levels

	Pitch Angle	Frequency Hz							
		63	125	250	500	1K	2K	4K	8K
$L_{WA}$	8 - 18	-26	-16	-9	-5	-5	-10	-15	-23
$L_W$	8 - 18	0	0	0	-2	-5	-11	-16	-22
$L_{WA}$	20 - 32	-26	-14	-10	-5	-6	-9	-12	-19
$L_W$	20 - 32	0	+2	-1	-2	-6	-10	-13	-18

#### Outlet Levels

	Pitch Angle	Frequency Hz							
		63	125	250	500	1K	2K	4K	8K
$L_{WA}$	8 - 18	-22	-13	-7	-3	-3	-7	-12	-20
$L_W$	8 - 18	+4	+3	+2	0	-3	-8	-13	-19
$L_{WA}$	20 - 32	-21	-11	-7	-3	-4	-7	-10	-16
$L_W$	20 - 32	+5	+5	+2	0	-4	-8	-11	-15

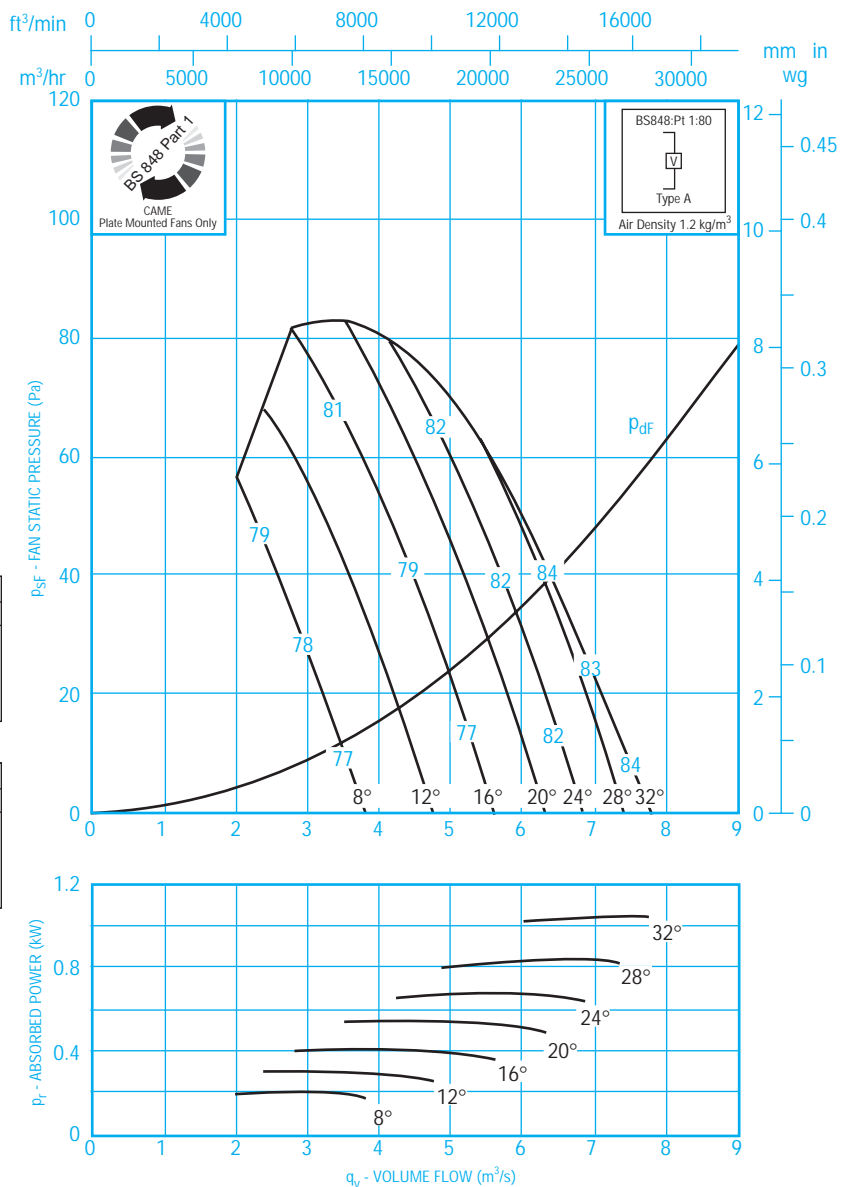

### Electrical Data

220-240 V / 50 Hz / 1  $\phi$

Chart No. 39

Motor	Fixed Speed				Speed Controllable					
	Pitch Angle (°)	Motor Rating (kW)	Full Load (A)	Starting Current (A)	Pitch Angle (°)	Motor Rating (kW)	Full Load (A)	Starting Current (A)	Speed Controller	
									Electronic	Auto-Transformer
F2265	22 - 26	0.8	5.9	12	16 - 22	0.65	4.9	12	ME1.6	MT1.8
F2269	34 - 36	1.4	10	20	30 - 34	1.1	8.2	19.5	ME1.10	MT1.8
-	-	-	-	-	-	-	-	-	-	-

380-420 V / 50 Hz / 3  $\phi$

Motor	Fixed Speed				Speed Controllable					
	Pitch Angle (°)	Motor Rating (kW)	Full Load (A)	Starting Current (A)	Pitch Angle (°)	Motor Rating (kW)	Full Load (A)	Starting Current (A)	Speed Control	
									Electronic	$\Delta/\Lambda$ * Pitch Angle
F2265	8 - 26	0.8	2.8	8	16 - 22	0.65	2.4	8	ME3.2D	22
F2269	28 - 36	1.4	4.7	14	30 - 34	1.1	3.8	14	-	34
-	-	-	-	-	-	-	-	-	-	-

\* By connecting these 3 phase motors in star ( $\Lambda$ ), a second speed will be obtained approximately 80% of the full speed at the angle shown. (A Woods two speed switch type MDS3.10 is available). For dimensions and weights of this fan please refer to pages 54 and 55.

# AEROFOIL CLIMAFAN



## Fan Code: 100AC/8/6/...

## 1000 mm 695 rev/min 6 Blades 50 Hz

### Performance Data

#### BS 848 Pt 1 1980

Performance shown is specifically for non-ducted installations.

### Sound Data

#### BS 848 Pt 2 1985

Single figures on performance curves are overall inlet sound power levels, "A" weighted ( $L_{WA}$  re: 1 pW), derived from measurements taken in Woods laboratory specifically under non-ducted free field conditions. For sound power levels in eight octave bands, apply the following corrections to the overall level:

#### Inlet Levels

	Pitch Angle	Frequency Hz							
		63	125	250	500	1K	2K	4K	8K
$L_{WA}$	8 - 18	-27	-16	-10	-5	-4	-10	-15	-23
$L_W$	8 - 18	-1	0	-1	-2	-4	-11	-16	-22
$L_{WA}$	20 - 36	-24	-14	-10	-5	-5	-9	-12	-18
$L_W$	20 - 36	+2	+2	-1	-2	-5	-10	-13	-17

#### Outlet Levels

	Pitch Angle	Frequency Hz							
		63	125	250	500	1K	2K	4K	8K
$L_{WA}$	8 - 18	-20	-15	-6	-3	-2	-7	-13	-20
$L_W$	8 - 18	+6	+1	+3	0	-2	-8	-14	-19
$L_{WA}$	20 - 36	-18	-12	-5	-3	-3	-6	-10	-15
$L_W$	20 - 36	+8	+4	+4	0	-3	-7	-11	-14

Three blade performance available. See chart number 39.

### Electrical Data

220-240 V / 50 Hz / 1  $\phi$

Chart No. 40

Motor	Fixed Speed				Speed Controllable					
	Pitch Angle (°)	Motor Rating (kW)	Full Load (A)	Starting Current (A)	Pitch Angle (°)	Motor Rating (kW)	Full Load (A)	Starting Current (A)	Speed Controller	
									Electronic	Auto-Transformer
F2265	12 - 14	0.8	5.9	12	10 - 12	0.65	4.9	12	ME1.6	MT1.8
F2269	20 - 24	1.4	10	20	18 - 20	1.1	8.2	19.5	ME1.10	MT1.8
-	-	-	-	-	-	-	-	-	-	-

380-420 V / 50 Hz / 3  $\phi$

Motor	Fixed Speed				Speed Controllable					
	Pitch Angle (°)	Motor Rating (kW)	Full Load (A)	Starting Current (A)	Pitch Angle (°)	Motor Rating (kW)	Full Load (A)	Starting Current (A)	Speed Control	
									Electronic	$\Delta/\Delta$ * Pitch Angle
F2265	8 - 14	0.8	2.8	8	10 - 12	0.65	2.4	8	ME3.2D	12
F2269	16 - 24	1.4	4.7	14	18 - 20	1.1	3.8	14	-	20
-	-	-	-	-	-	-	-	-	-	-

\* By connecting these 3 phase motors in star ( $\lambda$ ), a second speed will be obtained approximately 80% of the full speed at the angle shown. (A Woods two speed switch type MDS3.10 is available). For dimensions and weights of this fan please refer to pages 54 and 55.

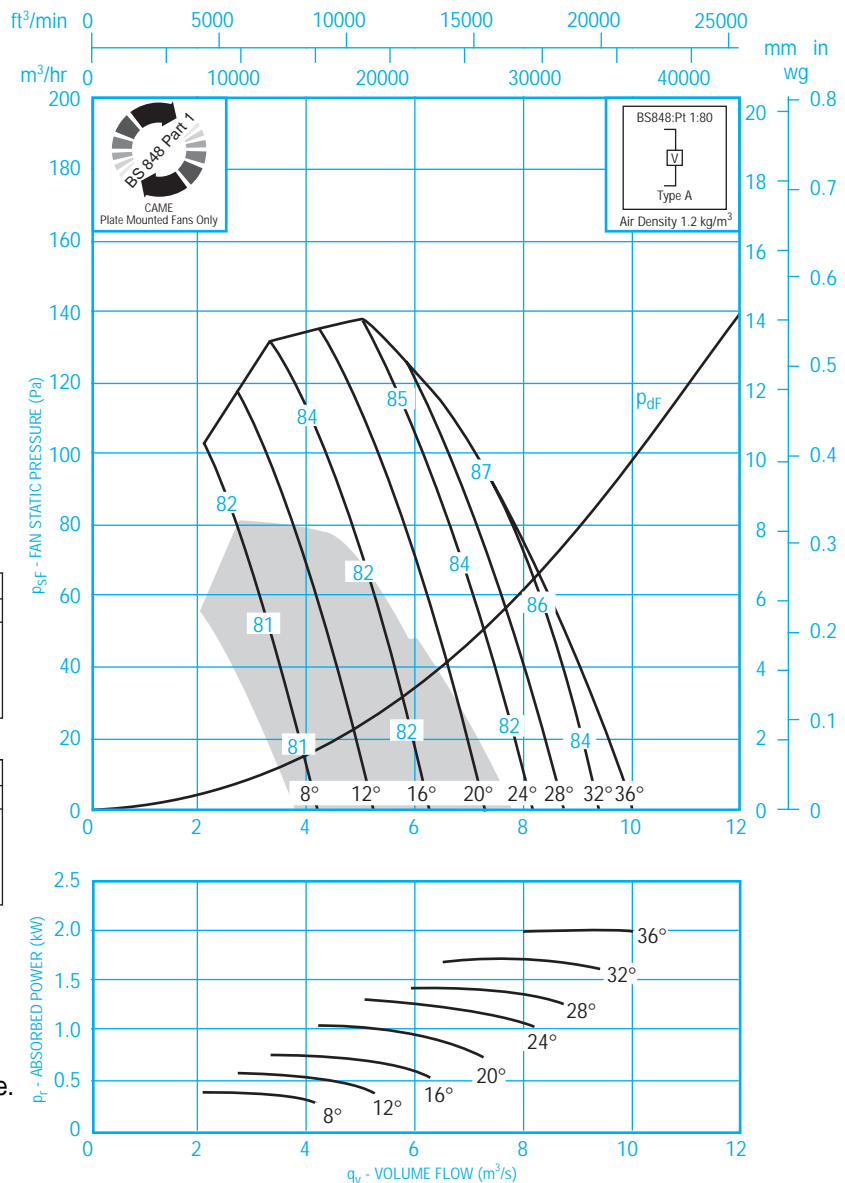

# AEROFOIL CLIMAFAN



BS 5750 Pt 1  
EN 29001  
ISO 9001

## Fan Code: 100AC/6/3/...

## 1000 mm 935 rev/min 3 Blades 50 Hz

### Performance Data

#### BS 848 Pt 1 1980

Performance shown is specifically for non-ducted installations.

### Sound Data

#### BS 848 Pt 2 1985

Single figures on performance curves are overall inlet sound power levels, "A" weighted ( $L_{WA}$  re: 1 pW), derived from measurements taken in Woods laboratory specifically under non-ducted free field conditions. For sound power levels in eight octave bands, apply the following corrections to the overall level:

#### Inlet Levels

	Pitch Angle	Frequency Hz							
		63	125	250	500	1K	2K	4K	8K
$L_{WA}$	8 - 18	-26	-16	-9	-5	-5	-10	-14	-23
$L_W$	8 - 18	0	0	0	-2	-5	-11	-15	-22
$L_{WA}$	20 - 32	-26	-14	-10	-4	-6	-9	-12	-19
$L_W$	20 - 32	0	+2	-1	-1	-6	-10	-13	-18

#### Outlet Levels

	Pitch Angle	Frequency Hz							
		63	125	250	500	1K	2K	4K	8K
$L_{WA}$	8 - 18	-22	-13	-7	-3	-3	-7	-12	-20
$L_W$	8 - 18	+4	+3	+2	0	-3	-8	-13	-19
$L_{WA}$	20 - 32	-21	-11	-7	-2	-4	-7	-10	-16
$L_W$	20 - 32	+5	+5	+2	+1	-4	-8	-11	-15

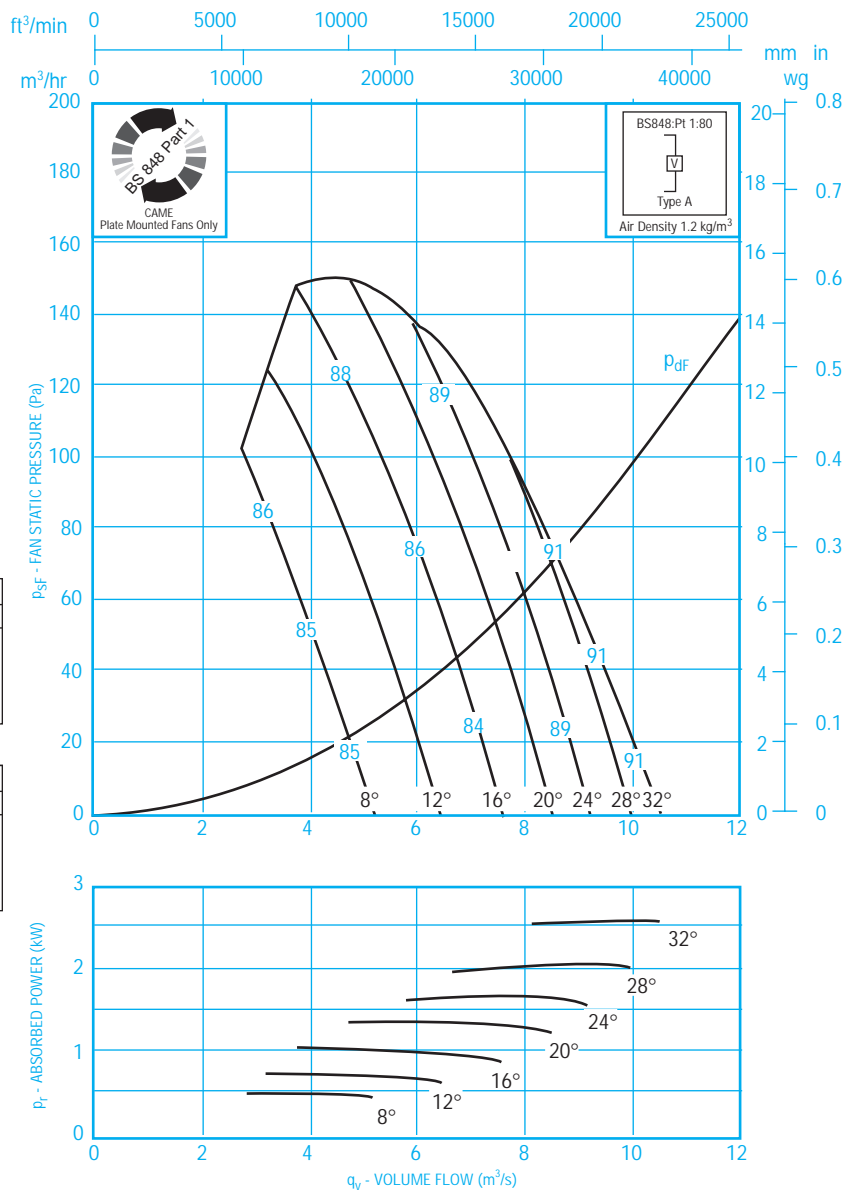

### Electrical Data

220-240 V / 50 Hz / 1  $\phi$

Chart No. 41

Motor	Fixed Speed				Speed Controllable						
	Pitch Angle (°)	Motor Rating (kW)	Full Load (A)	Starting Current (A)	Pitch Angle (°)	Motor Rating (kW)	Full Load (A)	Starting Current (A)	Speed Controller		
									Electronic	Auto-Transformer	
F2265	16 - 22	1.55	9.8	27	16 - 20	1.35	8.7	27	ME1.10	-	
F2269	26 - 32	2.5	16	48	26 - 28	2.1	13	39	-	-	
-	-	-	-	-	-	-	-	-	-	-	

380-420 V / 50 Hz / 3  $\phi$

Motor	Fixed Speed				Speed Controllable						
	Pitch Angle (°)	Motor Rating (kW)	Full Load (A)	Starting Current (A)	Pitch Angle (°)	Motor Rating (kW)	Full Load (A)	Starting Current (A)	Speed Control		
									Electronic	$\Delta/\Lambda$ * Pitch Angle	
F2265	8 - 22	1.55	4	15	16 - 20	1.35	3.6	15	-	20	
F2269	24 - 32	2.5	6.3	26	26 - 28	2.1	5.5	26	-	28	
-	-	-	-	-	-	-	-	-	-	-	

\* By connecting these 3 phase motors in star ( $\Lambda$ ), a second speed will be obtained approximately 80% of the full speed at the angle shown. (A Woods two speed switch type MDS3.10 is available). For dimensions and weights of this fan please refer to pages 54 and 55.

# AEROFOIL CLIMAFAN



## Fan Code: 100AC/6/6/...

## 1000 mm 935 rev/min 6 Blades 50 Hz

### Performance Data

#### BS 848 Pt 1 1980

Performance shown is specifically for non-ducted installations.

### Sound Data

#### BS 848 Pt 2 1985

Single figures on performance curves, "A" weighted ( $L_{WA}$  re: 1 pW), derived from measurements taken in Woods laboratory specifically under non-ducted free field conditions. For sound power levels in eight octave bands, apply the following corrections to the overall level:

#### Inlet Levels

	Pitch Angle	Frequency Hz							
		63	125	250	500	1K	2K	4K	8K
$L_{WA}$	8 - 18	-35	-18	-11	-6	-4	-7	-13	-21
$L_W$	8 - 18	-9	-2	-2	-3	-4	-8	-14	-20
$L_{WA}$	20 - 36	-28	-17	-9	-6	-5	-8	-11	-18
$L_W$	20 - 36	-2	-1	0	-3	-5	-9	-12	-17

#### Outlet Levels

	Pitch Angle	Frequency Hz							
		63	125	250	500	1K	2K	4K	8K
$L_{WA}$	8 - 18	-33	-12	-9	-3	-3	-5	-11	-18
$L_W$	8 - 18	-7	+4	0	0	-3	-6	-12	-17
$L_{WA}$	20 - 36	-26	-11	-7	-2	-4	-6	-9	-15
$L_W$	20 - 36	0	+5	+2	+1	-4	-7	-10	-14

Three blade performance available. See chart number 41.

### Electrical Data

220-240 V / 50 Hz / 1  $\phi$

Chart No. 42

Motor	Fixed Speed				Speed Controllable					
	Pitch Angle (°)	Motor Rating (kW)	Full Load (A)	Starting Current (A)	Pitch Angle (°)	Motor Rating (kW)	Full Load (A)	Starting Current (A)	Speed Controller	
									Electronic	Auto-Transformer
F2265	8 - 10	1.55	9.8	27	10	1.35	8.7	27	ME1.10	-
F2269	16 - 18	2.5	16	48	16	2.1	13	39	-	-
-	-	-	-	-	-	-	-	-	-	-

380-420 V / 50 Hz / 3  $\phi$

Motor	Fixed Speed				Speed Controllable					
	Pitch Angle (°)	Motor Rating (kW)	Full Load (A)	Starting Current (A)	Pitch Angle (°)	Motor Rating (kW)	Full Load (A)	Starting Current (A)	Speed Control	
									Electronic	$\Delta/\lambda$ * Pitch Angle
F2265	8 - 10	1.55	4	15	10	1.35	3.6	15	-	10
F2269	12 - 18	2.5	6.3	26	16	2.1	5.5	26	-	16
-	-	-	-	-	-	-	-	-	-	-

\* By connecting these 3 phase motors in star ( $\lambda$ ), a second speed will be obtained approximately 80% of the full speed at the angle shown. (A Woods two speed switch type MDS3.10 is available). For dimensions and weights of this fan please refer to pages 54 and 55.

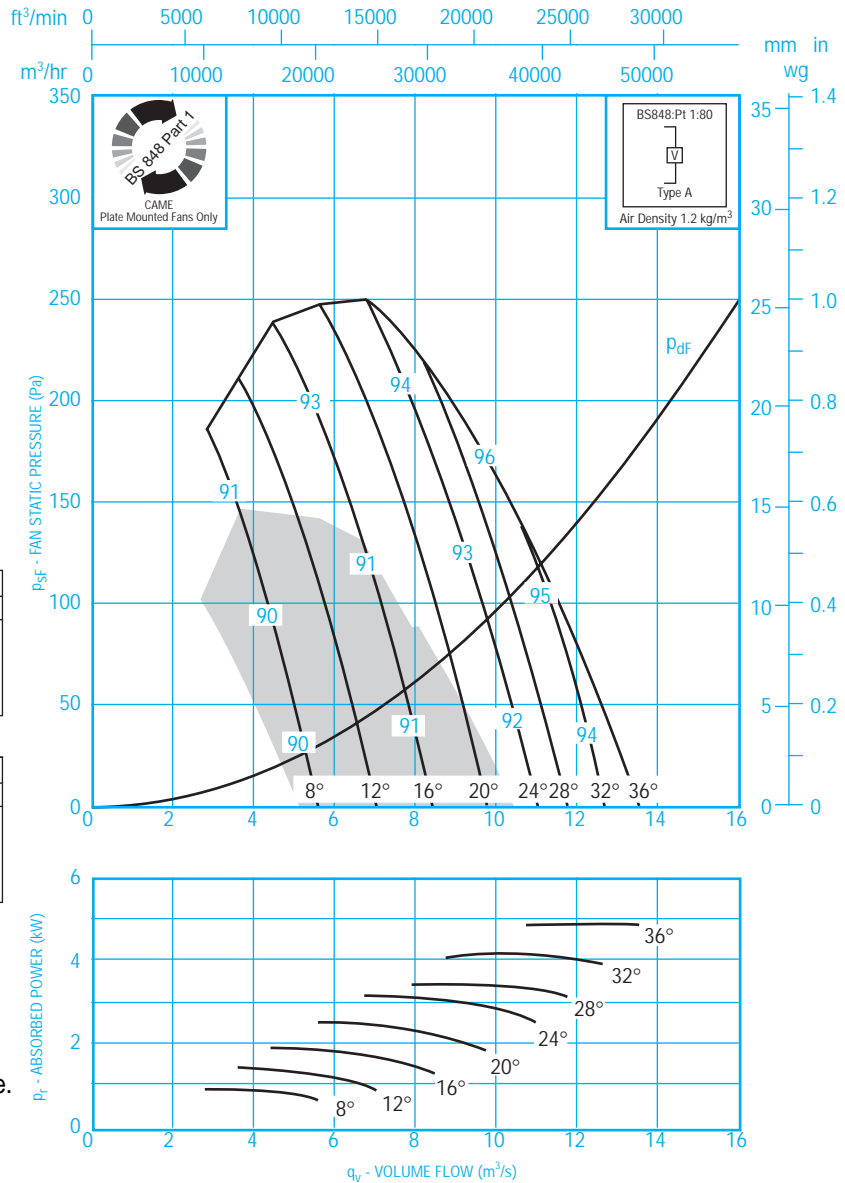



## DIMENSIONS AND WEIGHTS

### PLATE MOUNTED

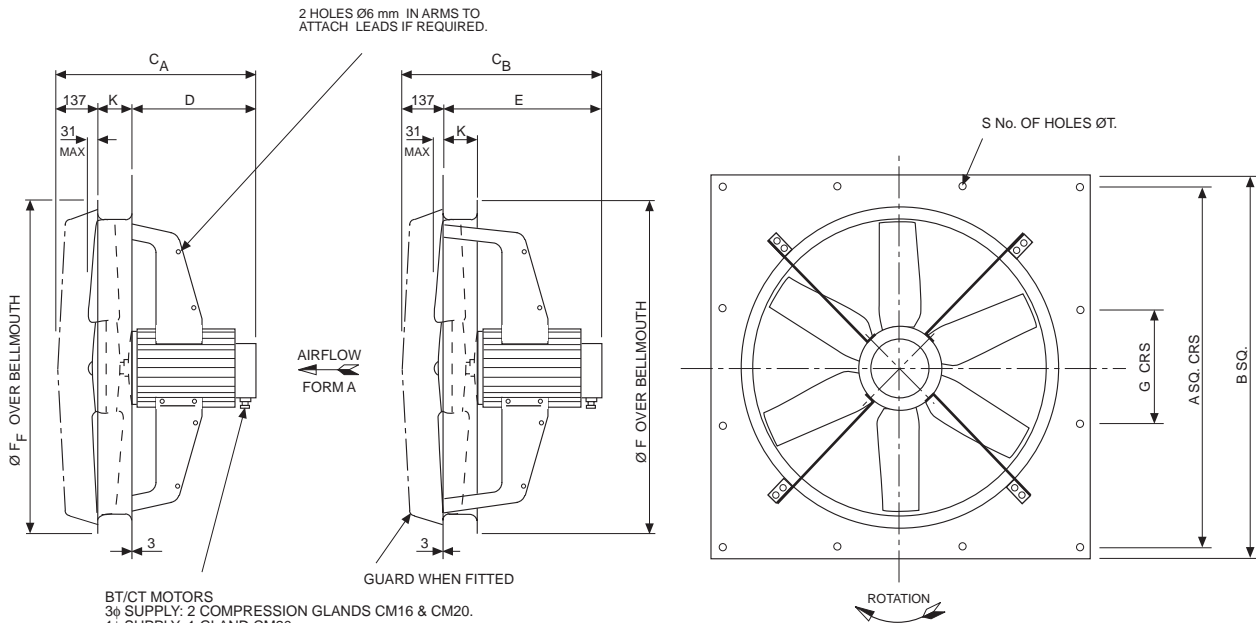

BT/CT MOTORS  
 3ø SUPPLY: 2 COMPRESSION GLANDS CM16 & CM20.  
 1ø SUPPLY: 1 GLAND CM20.  
 CM20 COMPRESSION GLAND SUITABLE FOR CABLE Ø8-13 mm.  
 CM16 SUITABLE FOR CABLE Ø4-7 mm.

F22 MOTORS  
 ENTRY FOR CM25 CONDUIT  
 SUITABLE FOR CABLE Ø8-13 mm.

Code	Motor Frame	A	B	C <sub>A</sub>	C <sub>B</sub>	D	E	F	F <sub>F</sub>	G	K	S	T	Weight kg
500	BT4/5	638	678	430	403	170	266	598	594	-	123	4	12	20
	BT9	638	678	465	438	205	301	598	594	-	123	4	12	21
	CT5	638	678	440	413	180	276	598	594	-	123	4	12	22
	CT9	638	678	480	453	220	316	598	594	-	123	4	12	26
	F2225	638	678	537	510	277	373	598	594	-	123	4	12	33
	F2229	638	678	591	564	331	427	598	594	-	123	4	12	44
560	CT5	698	738	440	413	180	276	658	654	-	123	4	12	24
	CT9	698	738	480	453	220	316	658	654	-	123	4	12	28
630	CT5	768	808	410	413	180	276	728	724	-	93	4	12	26
	CT9	768	808	450	453	220	316	728	724	-	93	4	12	30
	F2245/65	768	808	507	510	277	373	728	724	-	93	4	12	38
	F2249/69	768	808	561	564	331	427	728	724	-	93	4	12	49
710	CT5	848	888	410	413	180	276	808	804	-	93	4	12	28
	CT9	848	888	450	453	220	316	808	804	-	93	4	12	32
	F2245/65	848	888	507	510	277	373	808	804	-	93	4	12	39
	F2249/69	848	888	561	564	331	427	808	804	-	93	4	12	50
800	CT9	966	1000	450	453	220	316	898	894	322	93	12	12	35
	F2245/65	966	1000	507	510	377	373	898	894	322	93	12	12	43
	F2249/69	966	1000	561	564	331	427	898	894	322	93	12	12	54
900	CT9	1062	1100	450	453	220	316	998	994	354	93	12	12	38
	F2245/65	1062	1100	507	510	277	373	998	994	354	93	12	12	46
	F2249/69	1062	1100	561	564	331	427	998	994	354	93	12	12	57
1000	F2245/65	1207	1245	507	510	277	373	1098	1094	381	93	12	14	53
	F2249/69	1207	1245	561	564	331	427	1098	1094	381	93	12	14	64

All dimensions in millimetres

## DIMENSIONS AND WEIGHTS

### SHORT CASED

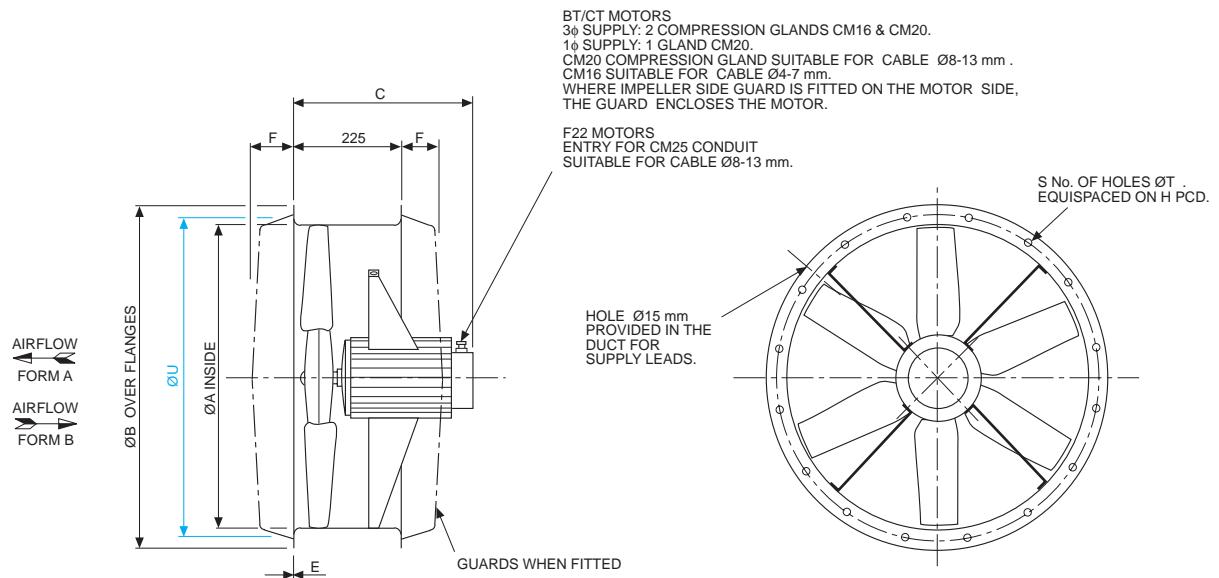

Code	Motor Frame	A	B	C	E	F	H	S	T	U *	Weight kg
500	BT4/5	500	594	301	3	137	560	12	12	541	17
	BT9	500	594	333	3	137	560	12	12	541	18
	CT5	500	594	308	3	137	560	12	12	541	23
	CT9	500	594	348	3	137	560	12	12	541	26
	F2225	500	594	404	3	137	560	12	12	541	33
	F2229	500	594	459	3	137	560	12	12	541	44
560	CT5	560	654	308	3	137	620	12	12	601	24
	CT9	560	654	348	3	137	620	12	12	601	27
630	CT5	630	724	308	3	137	690	12	12	671	27
	CT9	630	724	348	3	137	690	12	12	671	30
	F2245/65	630	724	404	3	137	690	12	12	671	37
	F2249/69	630	724	459	3	137	690	12	12	671	48
710	CT5	710	804	308	3	137	770	16	12	751	29
	CT9	710	804	348	3	137	770	16	12	751	32
	F2245/65	710	804	404	3	137	770	16	12	751	41
	F2249/69	710	804	459	3	137	770	16	12	751	51
800	CT9	800	894	348	3	137	860	16	12	841	37
	F2245/65	800	894	404	3	137	860	16	12	841	44
	F2249/69	800	894	459	3	137	860	16	12	841	55
900	CT9	900	994	348	3	137	970	16	12	941	40
	F2245/65	900	994	404	3	137	970	16	12	941	47
	F2249/69	900	994	459	3	137	970	16	12	941	58
1000	F2245/65	1000	1106	404	3	137	1070	16	15	1041	52
	F2249/69	1000	1106	459	3	137	1070	16	15	1041	63

\* Recommended customer plate opening diameter  
 All dimensions in millimetres

## ANCILLARIES

### SILENCER - B TYPE

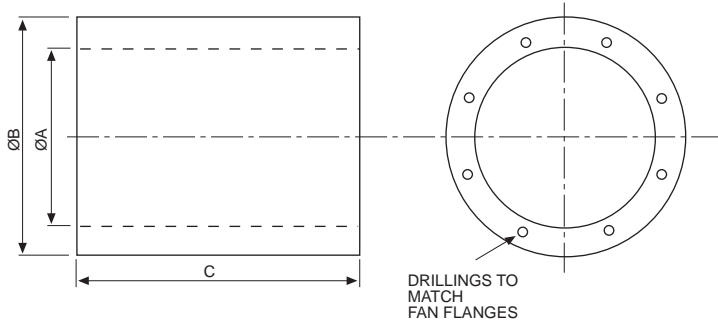

Suitable for fan Code	A	B	C	Weight (kg) B type
500	500	650	500	25
560	560	710	560	30
630	630	780	630	35
710	710	860	710	44
800	800	1000	800	55
900	900	1100	900	70
1000	1000	1200	1000	82

The above silencers give the following approximate dB(A) reductions:-  
B Type 1 diameter length - 7 to 10 dB(A)

For full acoustic details see publication AF1.3c or contact our Woods Acoustic Department. Tel: +44 (0) 1206 544122.

### MATCHING FLEXIBLE DAMPER FLANGE CONNECTION

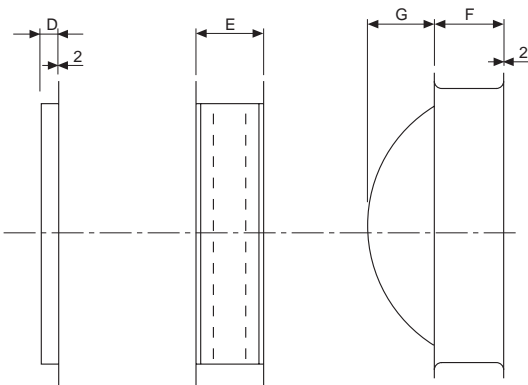

Suitable for fan Code	D	E	F	G	Weight (kg)		
					Matching Flange	Flexible Connection	Damper
500	32	110	225	75	2.0	4.8	14
560	32	110	225	125	2.3	5.5	15
630	50	160	225	176	3.0	7.5	17
710	50	160	225	210	3.2	8.1	19
800	50	160	225	266	3.6	9.1	21
900	50	160	225	301	4.1	10.4	24
1000	50	160	225	345	4.6	11.6	27

### SPEED CONTROLLER

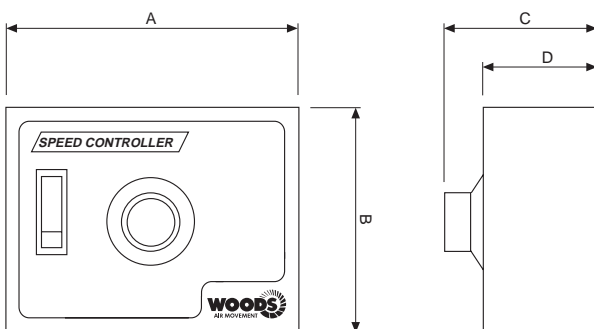

Type	A	B	C	D
ME1.1	104	83	55	40
ME1.3	148	87	62	47
ME1.6	148	87	62	47
MT1.1	124	124	60	52
MT1.2	160	270	196	161
MT1.5	160	270	196	161
MT1.8	160	270	196	161
MT3.0-5	160	270	196	161
MT3.1	160	270	196	161
MT3.2D	160	270	196	161

## USEFUL INFORMATION

### FAN LAWS

#### SPEED CHANGE - CONSTANT SIZE - CONSTANT DENSITY

Volume Flow  $\propto$  Rotational Speed  
 Pressure (Static, Velocity and Total)  $\propto$  (Rotational Speed)<sup>2</sup>  
 Power Absorbed  $\propto$  (Rotational Speed)<sup>3</sup>

#### SIZE CHANGE - CONSTANT SPEED - CONSTANT DENSITY

(For geometrically similar fans only)

Volume Flow  $\propto$  (Impeller Diameter)<sup>3</sup>  
 Pressure (Static, Velocity and Total)  $\propto$  (Impeller Diameter)<sup>2</sup>  
 Power Absorbed  $\propto$  (Impeller Diameter)<sup>5</sup>

#### DENSITY CHANGE - CONSTANT SPEED - CONSTANT SIZE

Volume Flow = No change  
 Pressure (Static, Velocity and Total)  $\propto$  Density  
 Power Absorbed  $\propto$  Density

The laws can be combined where simultaneous changes in size speed and density are required.

### AIR DENSITY

Standard density is 1.2 kg/m<sup>3</sup>

One condition which gives standard air is:-

16°C, 100 kPa barometric pressure, 65% relative humidity

#### CHANGE DUE TO TEMPERATURE

$$\text{Density 2} = \text{Density 1} \times \left( \frac{273 + \text{Temperature 1 } ^\circ\text{C}}{273 + \text{Temperature 2 } ^\circ\text{C}} \right) \text{ kg/m}^3$$

#### CHANGE DUE TO ALTITUDE

$$\text{Density 2} = \text{Density 1} \times \left( \frac{288 - 0.00649 H}{288} \right)^{4.256} \text{ kg/m}^3$$

Where H = Height above sea level in metres

### PRESSURE

$$P_d = 0.5\rho V^2 \text{ Pa}$$

Where  $\rho$  = Air Density kg/m<sup>3</sup>  
 $V$  = Air Velocity m/s

$$P_f = P_s + P_d$$

### ABSORBED POWER

$$\text{Absorbed Power} = \frac{q_v \text{ (m}^3\text{/s)} \times P_f \text{ (Pa)}}{\text{Total Efficiency \%} \times 10} \text{ kW}$$

## USEFUL INFORMATION

### CONVERSIONS

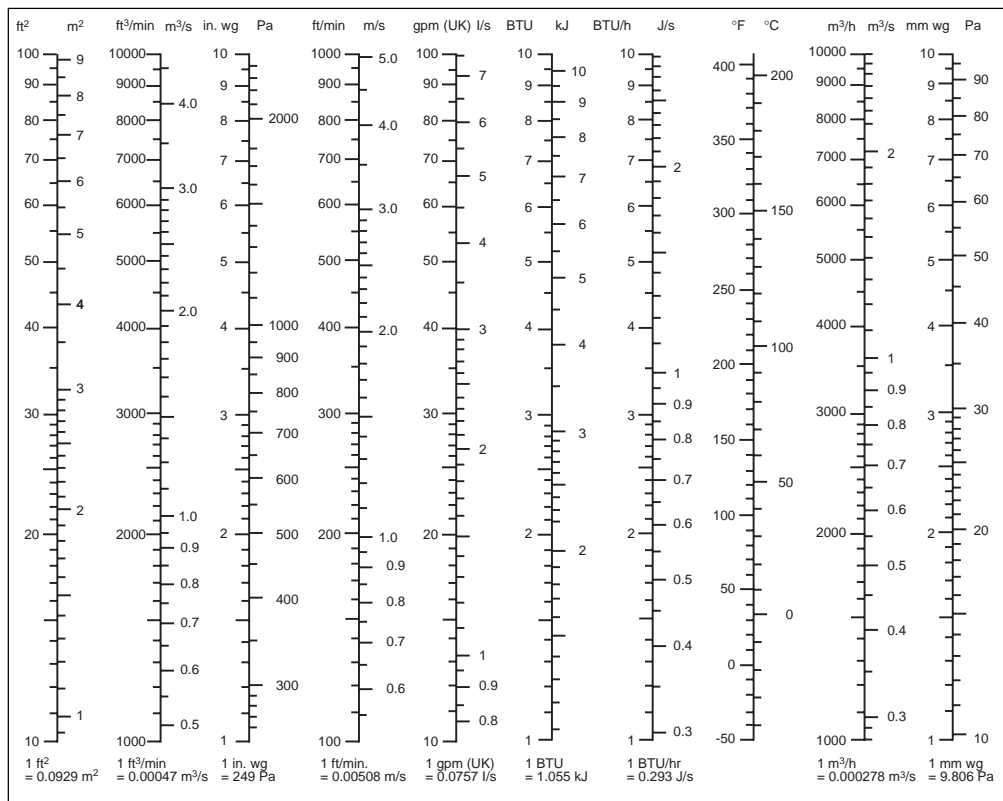

### MOTOR ENCLOSURES - DEGREES OF PROTECTION

Designation	1st Numeral	2nd Numeral
		Protection against contact and ingress of foreign bodies.
IP44	Protection against contact with live or moving parts of tools, wires or other objects of thickness greater than 1mm. Protection against the ingress of solid foreign bodies with a diameter greater than 1mm.	Water splashed against the motor from any direction shall have no harmful effect.
IP54	Complete protection against contact with live or moving parts inside the enclosure. Protection against harmful deposits of dust. The ingress of dust is not totally prevented, but dust cannot enter in an amount sufficient to interfere with satisfactory operation of the machine.	Water splashed against the motor from any direction shall have no harmful effect.
IP55		Water projected by a nozzle against the motor from any direction shall have no harmful effect.
IP56		Motor protected against conditions on a ship's deck.